

ORBIS®

energía inteligente®



General Catalogue

orbis.es
orbisenergiainteligente.com

- › INSTALLATION AND CONTROL
- › MEASUREMENT AND ENERGY
- › CLIMATE AND COMFORT
- › STREET LIGHTNING
- › INSTRUMENTATION



INSTALLATION AND CONTROL

(PAGS. 5-24)



MEASUREMENT AND ENERGY

(PAGS. 25-32)



CLIMATE AND COMFORT

(PAGS. 33-40)



STREET LIGHTING

(PAGS. 41-52)



INSTRUMENTATION

(PAGS. 53-56)



INSTALLATION AND CONTROL

PÁG. 6 | MODULAR TIME SWITCHES



UNO INCA DUO SUPRA SUPRA 2 ESFERAS

PÁG. 7 | ANALOG TIME SWITCHES



CRONO ALPHA MINI MINI T

PÁG. 8 | DIGITAL TIME SWITCHES



DATA MICRO + DATA MICRO 2+ DATA LOG DATA LOG 2 DATA LOG + DATA LOG 2+ MINI LOG MINI T LOG DATA MULTI ANUAL

PÁG. 10 | CONTROL UNITS FLUSH-MOUNTING



ILUMATIC 248 ILUMATIC 348 ROLLMATIC SERIE DECO

PÁG. 12 | PLUG-IN TIMERS



CONTROL DOMO DOMO INTEMPERIE TEMPO +

PÁG. 13 | TOKENS OR COINS TIME SWITCHES



CTM CTM ELECTRONICO BASICO CTM ELECTRONICO

PÁG. 16 | STAIRCASE TIME SWITCHES



T-16G T-22 T-11 20A PULSALUZ PULSAMAT ORBITEMP MICROTEMP

PÁG. 18 | MOVEMENT SENSOR SWITCHES



ISIMAT / ISIMAT + MULTIMAT ORBIMAT PROXIMAT ECOMAT CIRCUMAT SERIE DICROMAT

PÁG. 23 | DOOR BELLS/HOUR COUNTERS



ORBISON / ORBISON DUO CONTA EMPOTRABLE CONTA MODULAR

PÁG. 24 | LEVEL CONTROL RELAY/PHASE DISCONNECTOR



EBR-1 EBR-2 FR12-1

MODULAR TIME SWITCHES

UNO



INCA DUO



DUO



SUPRA



SUPRA (2 SPHERES)



Description

Modular time switches to timer circuits such as illumination, acclimatization, pumps, etc. DIN rail mounting.

Features

Battery back-up	D: No reserve QRD: 150 hours minimum Interchangeable battery QRS: 100 hours minimum	D: No reserve QRD and QRS: 100 hours minimum	D: No reserve QRD / QRS: 150 hours minimum Interchangeable battery	D: No reserve QRD and QRS: 150 hours minimum Interchangeable battery	QRDD and QRDS: 100 hours minimum
Dial / minimum switching time	D and QRD: Daily/15 min.. QRS: Weekly 2 hours	D and QRD: Daily /15 min. QRS: Weekly 2 hours	D / QRD: Daily / 30 min. QRS: Weekly / 3,5 hours	D / QRD: Daily / 15 min. QRS: Weekly 2 hours	QRDD: Daily-Daily/30 min.-30 min. QRSD: Weekly-Daily / 4 hours 30 min.
Rated voltage	120 or 230 Va.c. 12, 24 or 48 Va.c. / d.c.	120 or 230 Va.c. 12, 24 or 48 Va.c. / d.c.	120 or 230 Va.c. 12, 24 or 48 Va.c. or c.c.	120 or 230 Va.c. 12, 24 or 48 Va.c. / d.c.	120 or 230 Va.c. 12, 24 or 48 Va.c. / d.c.
Frequency	50/60 Hz	50/60 Hz	50/60 Hz	50/60 Hz	50/60 Hz
Switching capacity	16 (4) A / 250 Va.c.	16 (4) A / 250 Va.c.	16 (4) A / 250 Va.c.	16 (4) A / 250 Va.c.	2 x 16 (4) A / 250 Va.c.
Contact	Single	Changeover	Changeover	Changeover	2 x Changeover
Maxim. recommended load					
Incandescent	3000 W	3000 W	3000 W	3000 W	3000 W
Fluorescent	500 W	500 W	1200 W	1200 W	500 W
Low voltage halogen	2000 VA	2250 VA	2000 VA	2000 VA	2250 VA
Halogen (230 Va.c.)	3000 W	3000 W	3000 W	2000 W	3000 W
Low consumption lamps	500 W	500 W	900 W	900 W	500 W
LED	500 W	-	1000 W	1000 W	-
Operating temperature	-10°C to +45°C	-10°C to +45°C	-10°C a +50°C	-10°C to +50°C	-10°C to +50°C
Installation	DIN rail	DIN rail	DIN Rail	DIN rail	DIN rail
Type of protection	IP 20	IP 20	IP 20	IP 20	IP 20

Connection diagram

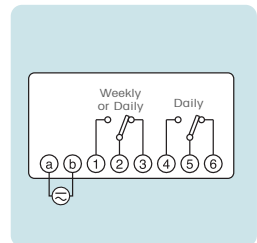
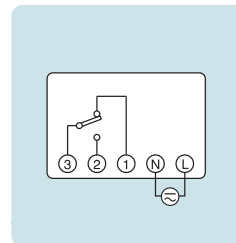
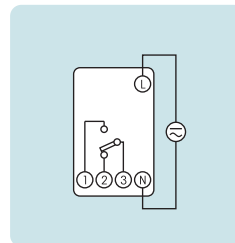
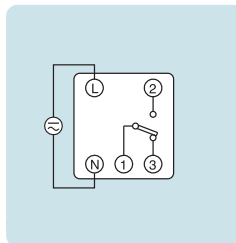
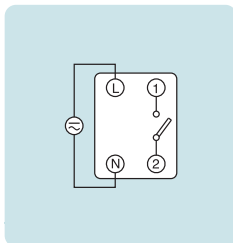

Dimensions

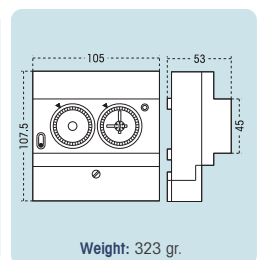
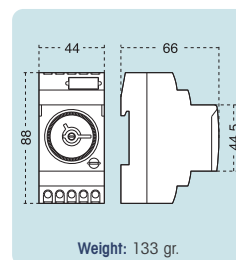
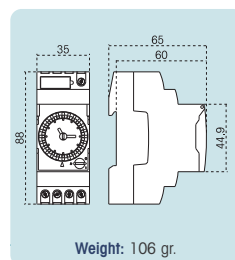
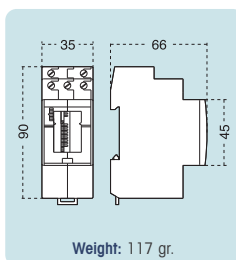
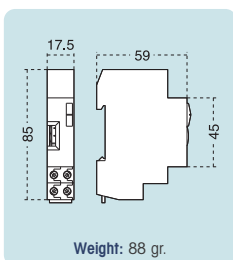

ANALOG TIME SWITCHES

CRONO



ALPHA



MINI / MINI T



Description

Analog time switches to timer circuits such as illumination, acclimatization, pumps, etc. DIN rail, Surface or Panel mounting.

Features

Battery back-up	QRD / QRDD / QRSD: 100 hours minimum Other models without battery back-up on request.	D / S: No reserve QRD / QRS: 100 hours minimum	D: No reserve QRD and QRS: 100 hours minimum
Dial / minimum switching time	QRD: Daily-15 min. QRDD: 2Daily-15 min. / 30 min. QRSD: Weekly-2 hours / Daily-30 min.	D: Daily / 15 min. S: Weekly / 2 hours QRD: Daily / 15 min. QRS: Weekly / 2 hours	D: Daily / 15 min. QRS: Weekly / 2 hours
Rated voltage	120 or 230 Va.c. 12, 24 or 48 Va.c. / d.c.	D / S: 120 or 230 Va.c. QRD/QRS: 120 or 230 Va.c. 6, 12, 24 or 48 Va.c. / d.c.	D: 120 or 230 Va.c. QRD/QRS: 120 or 230 Va.c. 6, 12, 24 or 48 Va.c. / d.c.
Frequency	50 / 60 Hz	D / S: 50 or 60 Hz QRD and QRS: 45/60 Hz	D: 50 or 60 Hz QRD and QRS: 50/60 Hz
Switching capacity	QRD: 16(4) A / 250 V; QRDD and QRSD: 2x16(4) A / 250 Va.c.	16 (4) A / 250 Va.c.	16 (4) A / 250 Va.c.
Contact	QRD: 1 Changeover QRDD and QRSD: 2 Changeovers	Changeover	Changeover
Maxim. recommended load Incandescent Fluorescent Low voltage halogen Halogen (230 Va.c.) Low consumption lamps LED	3000 W 500 W 2250 VA 3000 W 500 W -	2000 W 1200 W 2000 VA 2000 W 900 W 1000W	3000 W 1200 W 2000 VA 3000 W 900 W 1000 W
Operating temperature	-10°C to +50°C	-10°C to +50°C	D: 0°C to +55°C; QRD / QRS: -10°C to +45°C
Installation	Surface - Panel mounting (Faston connexions) DIN rail	Surface - Flush mounting (Faston connexions) DIN rail	MINI: DIN rail - Surface (sealable terminals). MINI T: DIN rail - Surface - Flush mounting (Faston connex.).
Protection type	IP 20	IP 20	IP 20

Connection diagram

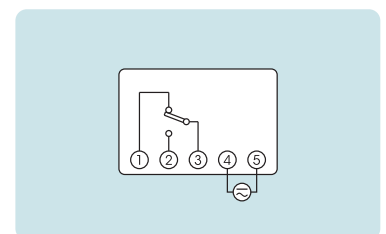
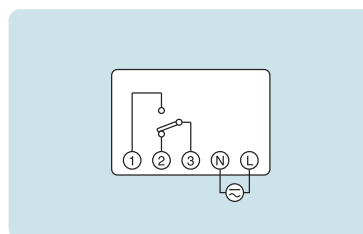
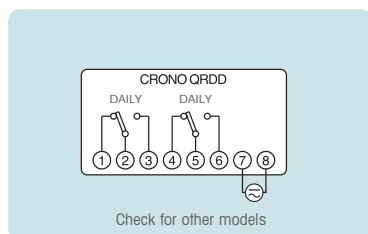

Dimensions

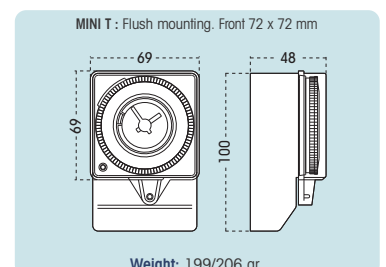
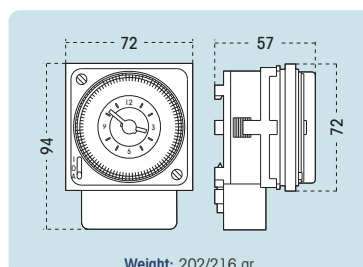
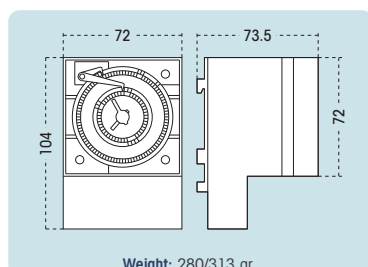

DIGITAL TIME SWITCHES

DATA MICRO + DATA MICRO 2+



DATA LOG DATA LOG 2



DATA LOG + DATA LOG 2+



MINI LOG MINI T LOG



Description

Modular time switches to timing electric circuits with programs by seconds, pulses, cycles, holiday period, running hour counter, etc. DIN, surface and panel mounting. The DATA LOG + series incorporates a large display with a backlight, interchangeable battery and remote programming via DATA REMOTE CONTROL.

Features

Battery back-up	4 years without power supply	5 years without power supply	5 years without power supply Interchangeable battery	5 years without power supply
Memory spaces	32 (programming by icon menus)	50 (programming by text menus)	70 (programming by text menus)	50 (programming by text menus)
Minimum switching time	On/Off program: 1 min. Pulse program: 1s	On/Off program: 1 min. Pulse program: 1s	On/Off program: 1 min. Pulse program: 1s	On/Off program: 1 min. Pulse program: 1s
Programme	Daily – Weekly. Pulse program (from 1 to 59 seconds), holidays and winter/summer automatic change.	Daily – Weekly. Pulse program (from 1 to 59 seconds), cycles, holidays and winter/summer automatic change, random and running hour counter.	Daily – Weekly. Pulse program (from 1 to 59 seconds), cycles, holidays and winter/summer automatic change, random and running hour counter.	Daily – Weekly. Pulse program (from 1 to 59 seconds), cycles, holidays and winter/summer automatic change, random and running hour counter.
Rated voltage	120 or 230 Va.c. 12, 24 or 48 Va.c. / d.c. 50-60 Hz	120 or 230 Va.c. 12, 24 or 48 Va.c. / d.c. 50-60 Hz	120 or 230 Va.c. 12, 24 or 48 Va.c. / c.c. 50-60 Hz	120 or 230 Va.c. 12, 24 or 48 Va.c. / d.c. 50-60 Hz
Contact	DATA MICRO +: Changeover DATA MICRO 2+: 2 x Changeover	DATA LOG: Changeover DATA LOG 2: 2 x Changeover	DATA LOG+: Changeover DATA LOG 2+: 2 x Changeover	Changeover
Maximum recommended load	Incandescent 3000 W Fluorescent 1200 W Low voltage halogen 2000 VA Halogen (230 Va.c.) 3000 W Low consumption lamps 400 W LED 600 W	3000 W 1200 W 2000 VA 3000 W 400 W 600 W	3000 W 1200 W 2000 VA 3000 W 400 W 600 W	1000 W By means of contactor 500 VA 1000 W By means of contactor -
Operating temperature	-10°C to +45°C	-10°C to +45°C	-10°C to +45°C	-10°C to +45°C
Installation	DIN Rail	DIN Rail	DIN Rail	MINI LOG: DIN rail - Surface (sealable terminals). MINI T LOG: DIN rail - Surface - Flush mounting (Faston connections).
Protection type	IP 20	IP 20	IP 20	IP 20 / IP 51
Connection diagram				
Dimensions	 Weight: 135/160 gr.	 Weight: 137/159 gr.	 Weight: 147/166 gr.	 Weight: 206/205 gr.



DIGITAL TIME SWITCHES

DATA MULTI ANUAL

DATA ANUAL



> Description

Digital time switches with daily, weekly, monthly and annual programming.
DIN rail mounting

> Features

Battery back-up	5 years without power supply	5 years without power supply
Memory spaces	100	50
Minimum switching time	ON/OFF Program: 1 min Pulse Program: 1 s	ON/OFF Program: 1 min Pulse Program: 1 s
Programming	Daily-weekly-monthly and annual. Configurable pulse program (1 to 59 sec.)	Daily-weekly-monthly and annual. Configurable pulse program (1 to 59 sec.)
Rated voltage	230 Va.c.	230 Va.c.
Switching capacity	4 x 16(10) A / 250 Va.c.	2 x 16(10) A / 250 Va.c.
Maximum recommended load		
Incandescent	1500 W	1500 W
Non-compensated fluorescent	600 W	600 W
Own consumption	3 VA approx.	8 VA approx.
Operating temperature	0°C to +50°C	0°C to +50°C
Installation	DIN Rail	DIN Rail
Protection type	IP 20	IP 20

Connection diagram

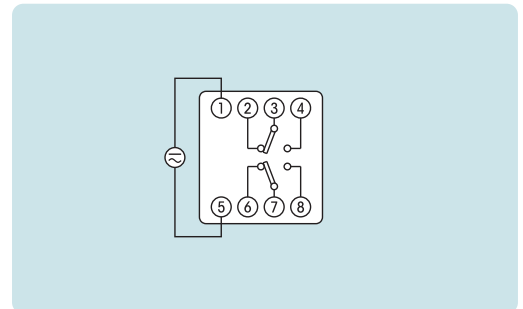
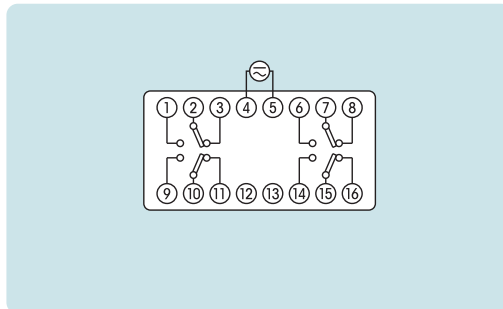

Dimensions

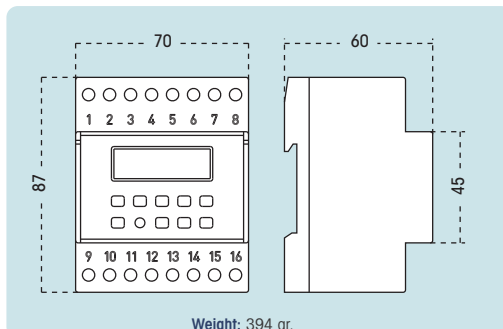

Weight: 394 gr.

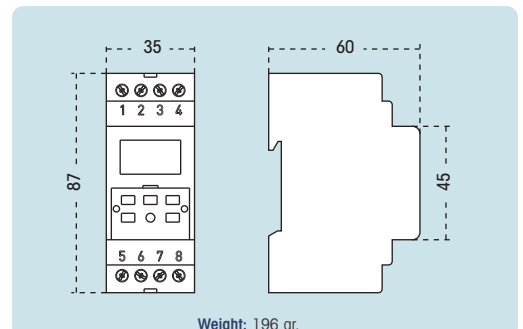

Weight: 196 gr.

CONTROL UNITS - FLUSH MOUNTING

ILUMATIC 248



ILUMATIC 348



ROLLMATIC



> Description

ANALOG devices to timing circuits such as lighting, blinds, etc. They are easy to install and programmable by means of pins.

> Features

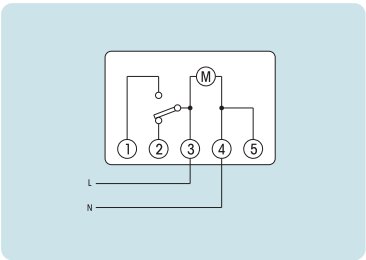
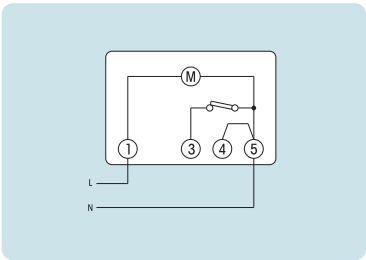
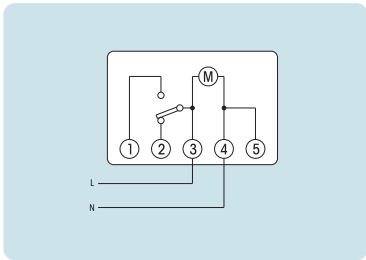
Rated voltage	230 Va.c. / 50 Hz	230 Va.c. / 50 Hz	230 Va.c. / 50 Hz
Switching capacity	10(4) A / 230 Va.c.	10(4) A / 230 Va.c.	10(2) A / 230 Va.c.
Own consumption	1, 6 VA	1, 6 VA	1, 6 VA
Maximum recommended load	2200 W	2200 W	2200 W
Manual control	ON - OFF - Automatic	ON - OFF - Automatic	Up - Stop - Down Automatic - OFF - Manual
Action	Programmable time switch	Programmable time switch	Programmable time switch for awnings, blinds, etc.
Sphere	D (daily): 24 hours S (weekly): 7 days	D (daily): 24 hours S (weekly): 7 days	D (daily): 24 hours S (weekly): 7 days
Minimum time operation	D (daily): 30 min. S (weekly): 1 h. 45 min.	D (daily): 30 min. S (weekly): 1 h. 45 min.	D (daily): 30 min. S (weekly): 1 h. 45 min.
Installation	Mechanism box	Mechanism box	Mechanism box
Protection type	IP 20	IP 20	IP 20
Connexion diagram			

Dimensions

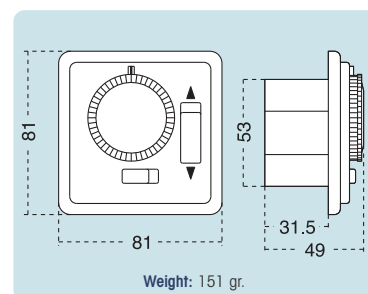
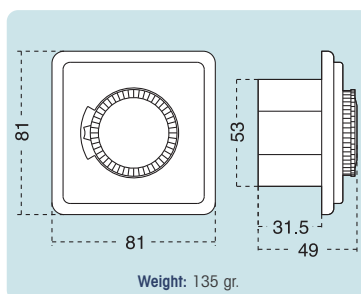
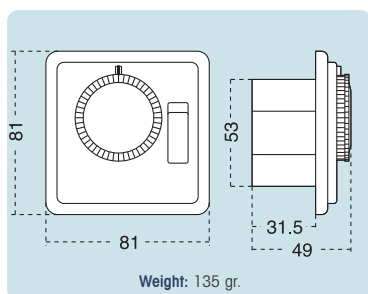

CONTROL UNITS - FLUSH MOUNTING

ALARM CLOCK

DECO-TEMPO



THERMOSTAT

DECO-TERMO



CRONOTHERMOSTAT

DECO-CRONO



BLINDS CONTROLLER

DECO-ROLL



TIME SWITCH

DECO-DATA



ASTRONOMIC SWITCH

DECO-ASTRO



Description

Build in devices for mechanism box and digital programming. Different models: alarm clock, thermostat, cronothermostat, time switch and blind controller. Time switch to control any type of electrical circuit and time switch.

Features

Nominal voltage	230 Va.c. / 50 Hz	230 Va.c. / 50 Hz	230 Va.c. / 50 Hz	230 Va.c. / 50 Hz	230 Va.c. / 50 Hz	230 Va.c. / 50 Hz
Switching capacity	-	8 (2) A / 250 Va.c.	8 (2) A / 250 Va.c.	2x 5 (1) A / 250 Va.c.	8 (2) A / 250 Va.c.	8 (2) A / 250 Va.c.
Battery backup	24 h. by means of super condenser	24 h. By means of super condenser	24 h. By means of super condenser	24 h. By means of super condenser	24 h. By means of super condenser	24 h. By means of super condenser
Operating temperature	0 °C to + 40 °C	0 °C to + 40 °C	0 °C to + 40 °C	0 °C to + 40 °C	0 °C to + 40 °C	0 °C to + 40 °C
Accuracy	1sg/24h at 23° C Quartz clock	1sg/24h at 23° C Quartz clock	1sg/24h at 23° C Quartz clock	1sg/24h at 23° C Quartz clock	1sg/24h at 23° C Quartz clock	1s/24h at 23° C Quartz clock
Maximum recommended load						
Incandescent	-	2000 W	2000 W	-	2000 W	2000 W
Fluorescent	-	1000 W	1000 W	-	1000 W	1000 W
Low voltage halogen	-	1000 VA	1000 VA	-	1000 VA	1000 VA
Halogen (230 Va.c.)	-	2000 W	2000 W	-	2000 W	2000 W
Low consumption lamps	-	400 W	400 W	-	400 W	400 W
LED	-	600 W	600 W	-	600 W	600 W
Protection type	IP 20	IP 20	IP 20	IP 20	IP 20	IP 20
Installation	Universal mechanism box	Universal mechanism box	Universal mechanism box	Universal mechanism box	Universal mechanism box	Universal mechanism box
Features	Date and time information. Alarm clock for domestic or hotel applications.	Heating and air conditioning control with two programmable temperature levels.	Air conditioning and heating systems control, two program temperatures.	Device for arising and lowering the blinds.	Automatization of circuits such as lighting, irrigation, etc.	On and off control for home lighting circuits in line with daylight hours.
Functions	Two alarms with or without rearmament, countdown. Holiday period. Backlight contrast adjustable. Languages: Spanish, English and Portuguese.	Thermostat function. Comfort, power saver and anti ice temperatures. Air conditioning or heating operation. Holiday program. Languages: Spanish, English and Portuguese	Comfort, power saver and anti ice temperatures. 8 programs + thermostat. Holiday program. Languages: Spanish, English and Portuguese.	Automatic or manual control by pulses or directly. Up to 20 manoeuvres. Randomly manoeuvres to presence pretend and holiday program. Languages: Spanish, English and Portuguese.	Automatic or manual control. Up to 20 manoeuvres. Minimum operation time 20 seconds, Holiday and randomly programming. Languages: Spanish, English and Portuguese.	Programming by city with correction. Up to 20 operations. Minimum time delay 1 s. Winter-summer configuration, off mode and contrast. Languages: Spanish, English and Portuguese.

Connexions

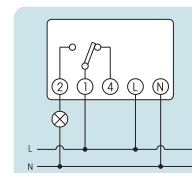
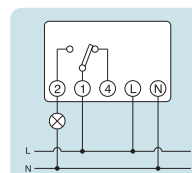
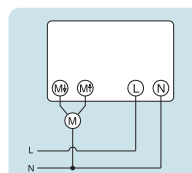
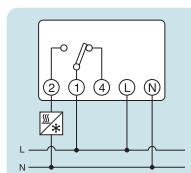
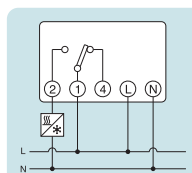
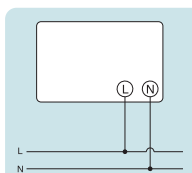

Dimensions

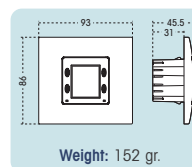
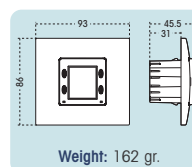
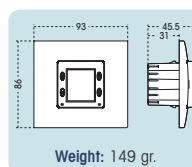
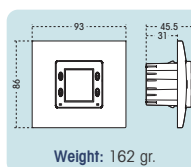
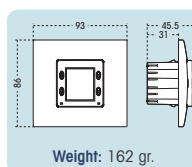
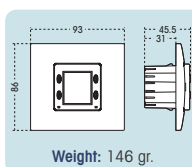

CONTROL



DOMO / DOMO / INTEMPERIE



TEMPO +



> Description

Timer switch for plug in devices, are useful in offices or domestic applications. Analogue, digital and even water prove models.

> Features

Nominal voltage	230 Va.c. / 50Hz.	230 Va.c. / 50Hz.	120 or 230 Va.c. / 24 or 48 Va.c. /d.c. / 50-60 Hz
Switching capacity	16(4) A 230 Va.c.	16(4) A 230 Va.c.	16(10) A / 230 Va.c. cos φ = 1
Battery backup	Without battery back up	Without battery back up	1 year without battery (Lithium CR2032)
Contact	-	-	AgSnO ₂ Changeover
Own consumption	1, 6 VA (1, 5 W approx.)	1, 6 VA (1, 5 W approx.)	6 VA (1W approx)
Memory spaces	-	-	32
Maximum recommended load			
Incandescent	3500 W	3500 W	3000 W
Fluorescents	Not suitable	Not suitable	180 W
Low voltage halogen	2250 VA	2250 VA	1000 VA
Halogen (230 Va.c.)	3500 W	3500 W	2500 W
Low consumption lamps	No suitable	No suitable	200 W
Accuracy	Depends on the net frequency	Depends on the net frequency	< ± 1 s/day at 23 °C
Programming	Lateral sphere D T15 - D T30: Daily S: Weekly	Front sphere D T15 - D T30: Daily S: Weekly M-60 - M 150 - M 900: Countdown	Digital Pulse programming (1 to 59 s), cycles, holiday, change s/w.
Minimum operation time	D T15: 15 min. D T30: 30 min. S: 1 h.-45 min.	D T15: 15 min. D T30: 30 min. S: 1 h. 45 min. M 60: 0-60 min. M 150: 0-150 min. M 900: 0-900 min.	1 second
Manual control	Automatic - Off - On	Automatic - Off - On	Automatic-Off-On
Model for outside	No	Domo Intemperie D T15, D T30 and S	No
Installation	Schuko 4, 8 mm socket type	Schuko 4, 8 mm socket type	Schuko 4, 8 mm socket type
Protection type	IP 20	IP 20 (IP 24 outdoor models)	IP 20
Operating temperature	0°C to +60°C	0°C to +60°C	-10 °C to +45 °C
Features	Children protection	Children protection	Children protection

Dimensions

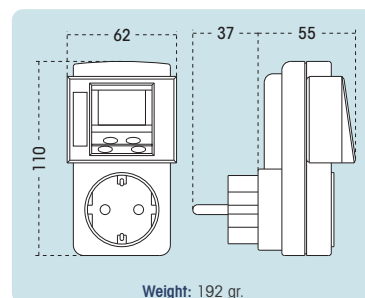
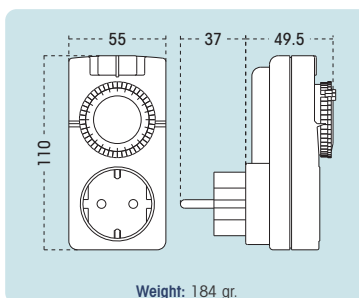
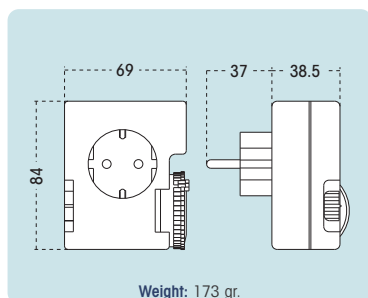



TOKENS OR COINS TIME COUNTER

CTM



CTM ELECT. BÁSICO



CTM ELECTRÓNICO



> Description

Timing of circuits by coins or tokens. Sport courts lighting in residences, washing machines in camp grounds, marinas, etc

> Features

Rated voltage	24, 120 or 230 Va.c. / 50Hz	12, 24, 48, 120 or 230 Va.c. / 45-60Hz	12, 24, 48, 120 or 230 Va.c. / 45-60Hz
Switching capacity	6(2) A / 250 Va.c.	10(2) A / 250 Va.c.	16(4) A / 250 Va.c.
Own consumption	2, 2 VA	5 VA	5 VA
Temporization memory	-	1 year	10 minutes
Operating accuracy	Depends of mains frequency	±0, 2%	±0, 2%
Operating temperature	-10 °C to +45 °C	-10 °C to +45 °C	-20 °C to +55 °C
Temporization per coin or tokens	1', 2', 3', 5', 10', 15', 30', 60', 90' or 120' (on demand)	Programmable from 1 min. to 150 hours	Programmable from 1 min. to 150 hours
Special temporization	No	No	Yes
Time ending advice	Optional	Yes	Yes
Protection type	IP 20	IP 20	IP 20
Features	<ul style="list-style-type: none"> • Electromechanical time counter, fixed timing at the factory. • Coins or tokens operated. • Possibility of timing from 1 minute up to 120 minutes. • With or without pre-warning of time ending 	<ul style="list-style-type: none"> • Electronic time counter. • Coins or tokens operated. • 1 digit display which counts up to 9 tokens or coins. • Pre warning of time ending by means of display flashing 1 minute before it finishes. 	<ul style="list-style-type: none"> • Electronic time counter. • Coins or tokens operated. • Independent lock, one for the Electronic and other for the coin box. • Pre warning by means of relay (short: 30 seconds before it finishes for 10 seconds; large: 4 minutes before it finishes for 10 seconds). • It stores up to 99 tokens or coins in memory.

To install in wet environment such as camp grounds, changing rooms, etc. a 24V transformer is necessary (on demand in separated box).

Connection diagram

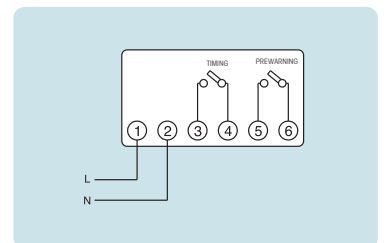
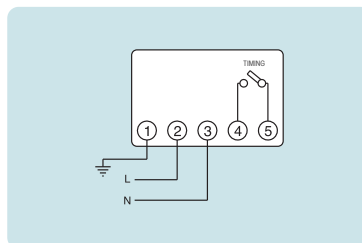
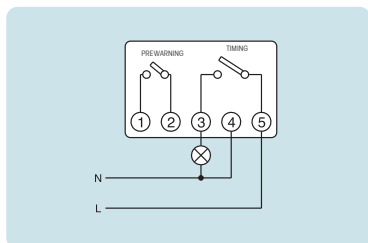

Dimensions

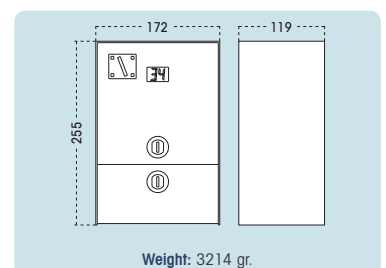
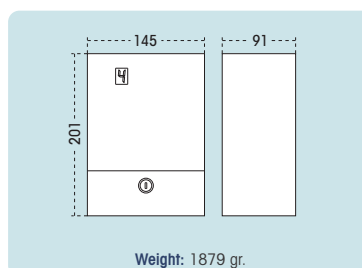
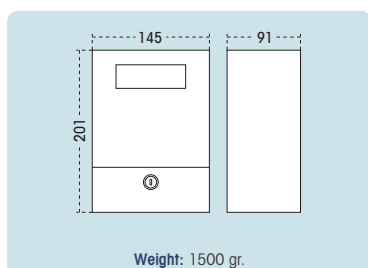



INDUSTRIAL TIME SWITCHES

MODUL



SINCRO 341/ 351 SINCRO 346 / 356



Description

Timer switch for industrial applications such as machinery, heating or air conditioning machines, etc. Personalized models are available with different mounting possibilities.

Designed for integration with any kind of equipment. Daily, weekly and countdown versions with different configuration, mounting and connexion possibilities. Different colours available on request.

Features

Power supply	120 Va.c. or 230 Va.c.	110 Va.c. or 230 Va.c.
Frequency	MODUL D, MODUL S: 50 or 60 Hz. MODUL QRD, MODUL QRS: 50/60 Hz	50 or 60 Hz.
Switching capacity	16(4) A / 250 Va.c.	16(4) A / 250 Va.c. 21(8) A / 250 Va.c.
Own consumption	1.8 VA	1.8 VA
Battery back-up	MODUL D, MODUL S: No reserve MODUL QRD, MODUL QRS: 100 hours	Without reserve
Dial / minimum switching time	MODUL D, MODUL QRD: Daily/15 min. MODUL S, MODUL QRS: Weekly/2 hours.	SINCRO 341 T15-346 T15: Daily/15 min. SINCRO 341 T30-346 T30: Daily/30 min. SINCRO 351-356: Weekly/105 min. SINCRO 341 K60-346 K60: Countdown/60 min. SINCRO 341 K150-346 K150: Countdown/150 min. SINCRO 341 K900-346 K900: Countdown/900 min.
Manual control	With (ON-Automatic-OFF) or without manual control	SINCRO 341/351: ON-OFF-Automatic. SINCRO 346/356: With (ON-OFF-Automatic) or without manual control
Clock hands	With or without	Without
Operating temperature	D and S: from 0°C to +55°C QRD and QRS: from -10°C to +45°C	from 0°C to +85°C

Connection diagram

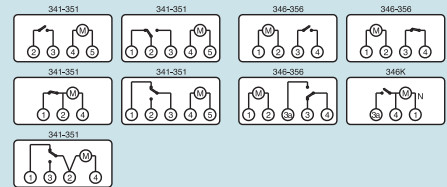
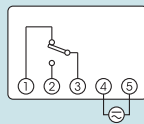

Dimensions

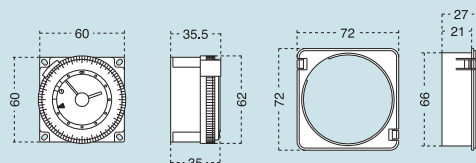

Weight: 97 gr.

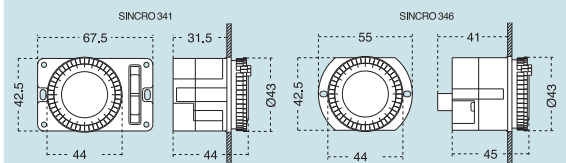

Weight: 88 gr.

MODUL LOG



DH-1 / DH-3



Description

Digital time switch for industrial applications. It has a switched contact with daily or weekly programming. Pulse programme (from 1 to 59 s.) cycles, s/w change, random and operating hours meter. Simple programming by text menu.

Timer to control the defrosting operation in cold rooms. Allows disconnection of compressor and ventilator and activation of the heating resistance. Small size adaptable at any installation, fast connection and different time delays available with synchronous motor.

Features

Power supply	120 or 230 Va.c. 12, 24 or 48 Va.c. / Vc.c.	120, 208 or 240 Va.c.
Frequency	50-60 Hz	50-60 Hz
Switching capacity	16(4)A / 250 Va.c.	-
Own consumption	6 VA	-
Battery Back-up	5 years	-
Dial/Minimum switching time	Daily/Weekly. ON/OFF Program: 1 min. Pulse Program: 1 s	-
Manual control	Offer manual and permanent drive	-
Hourly index	Display LCD	-
Operating temperature	-10°C to +45°C	Ambient temperature
Models	-	-

	Time between cycles		Time Defrost	
	50 Hz	60 Hz	50 Hz	60 Hz
DHD1-420 / DHD3-420	4h ±3'	3h 20' ±3'	20' ±3'	16' 40" ±3'
DHD1-621 / DHD3-621	6h ±3'	5h ±3'	21' ±3'	17' 30" ±3'
DHD1-625 / DHD3-625	6h ±3'	5h ±3'	25' ±3'	20' 50" ±3'
DHD1-803 / DHD3-803	8h ±3'	6h 40' ±3'	3' ±30"	2' 30" ±30"
DHD1-807 / DHD3-807	8h ±3'	6h 40' ±3'	7' ±3'	5' 50" ±3'
DHD1-825 / DHD3-825	8h ±3'	6h 40' ±3'	25' ±3'	20' 50" ±3'
DHD1-830 / DHD3-830	8h ±3'	6h 40' ±3'	30' ±3'	25' ±3'
DHD1-1025 / DHD3-1025	10h ±3'	8h 20' ±3'	25' ±3'	20' 50" ±3'
DHD1-1221 / DHD3-1221	12h ±3'	10h ±3'	21' ±3'	17' 30" ±3'
DHD1-2496 / DHD3-2496	24h ±3'	20h ±3'	96' ±3'	80' ±3'

Other time delays on request

Connection diagram

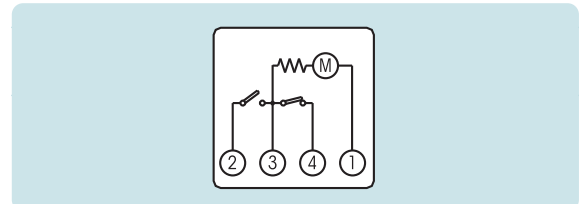
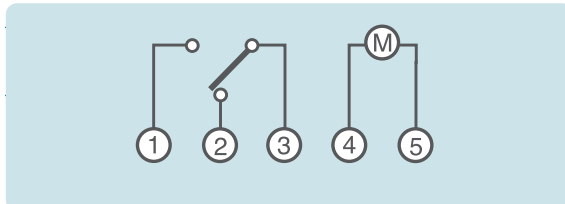

Dimensions

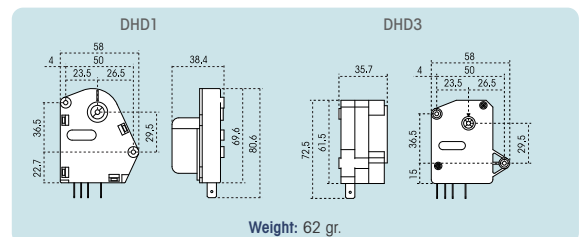
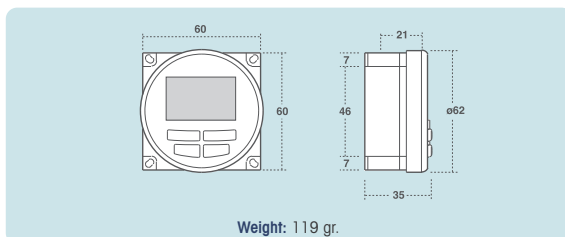

STAIRCASE TIME SWITCHES

T-16G



T-22



T-11 20A



Description

Timing of staircase light circuits in seconds or minutes, in offices and home buildings, community courtyards, etc. DIN rail and surface mounting.

Features

Resettable	Yes	Yes	Yes
Manual switch	ON - Automatic	ON – Automatic	ON - Off – Automatic
Rated voltage	120 or 230 Va.c.	120 or 230 Va.c.	120 or 230 Va.c.
Switching capacity	10 A / 230 Va.c.	16 (4) A / 230 Va.c.	20 A / 230 Va.c.
Luminous push buttons	50 mA max.	50 mA max.	50 mA max.
Maxim. recommended load			
Incandescent	2000 W	3000 W	4000 W
Compensated fluorescent	800 W	1200 W	1100 W 139 µF
Low voltage halogen	1200 VA	2000 VA	2000 VA
Halogen (230 Va.c.)	2000 W	3000 W	4000 W
Low consumption lamps	700 W	900 W	800 W
LED	750 W	1000 W	-
Temporization	3 min. to 30 min.	45 s to 7 min.	1 to 3 min.
Operating temperature	-10°C to +50°C	-10°C to +50°C	-10°C to +60°C
Installation	3 or 4 wires	3 or 4 wires	3 wires
Mounting	DIN Rail	DIN Rail	Surface
Protection type	IP 20	IP 20	IP 20

Connection diagram

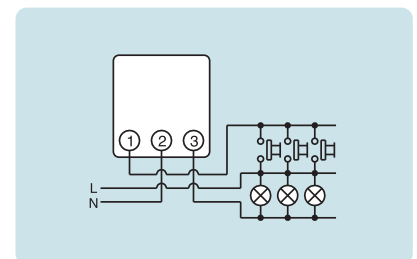
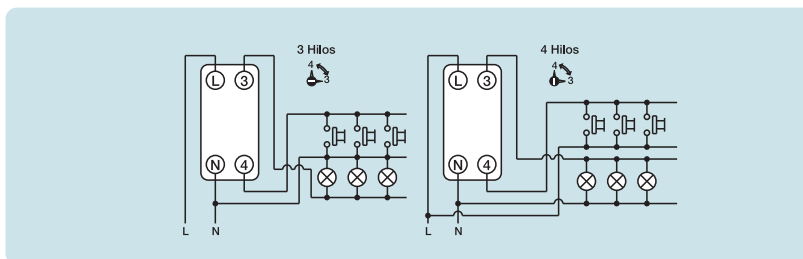

Dimensions

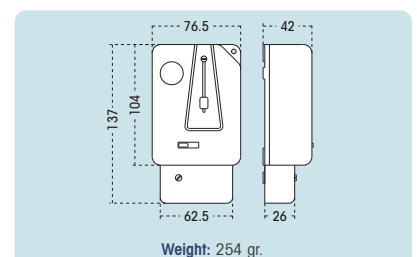
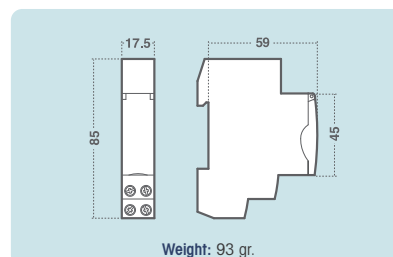
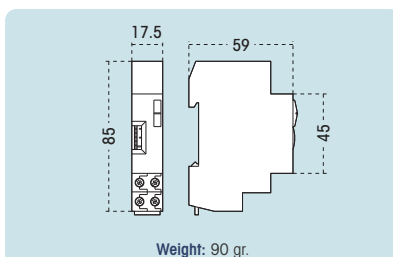

STAIRCASE TIME SWITCHES

PULSALUZ



PULSAMAT



ORBITEMP



MICROTEMP



Description

Timing of staircase light circuits in seconds or minutes, in offices and home buildings, community courtyard, etc. Mechanism or junction box mounting.

Features

Resettable	Yes	Yes	Yes	Yes
Rated voltage	120 or 230 Va.c. / 45-60 Hz	230 Va.c. / 50 Hz	120 or 230 Va.c. / 45-60 Hz	230 Va.c. / 50-60 Hz
Manual switch	1, 5 A / 230 Va.c.	3 A / 230 Va.c. ~ cos φ = 1	1, 5 A / 230 Va.c.	-
Luminous push buttons	6 mA / 230 V; 3mA / 120 V	6 mA max.	6 mA / 230 V; 3mA / 120 V	Unlimited
Maxim. recommended load				
Incandescent 230 V	25 W - 300 W	700 W	25 W - 300 W	25 W - 400 W
Incandescent 120 V	25 W - 150 W	-	25 W - 150 W	25 W - 200 W
Compensated fluorescent	36 W - 100 W	500 W	36 W - 100 W	36 W - 100 W
Low voltage halogen	50 VA - 150 VA	500 VA	50 VA - 150 VA	50 VA - 150 VA
Halogen (230 Va.c.)	18 W - 300 W	700 W	18 W - 300 W	18 W - 400 W
Low consumption lamps	21 W - 100 W	500 W	21 W - 100 W	21 W - 100 W
LED	Not suitable	500 W	Not suitable	Not suitable
Temporization	30 s to 4 min.	30 s to 10 min.	30 s to 4 min.	30 s to 10 min.
Operating temperature	-10°C to +50°C	-10°C to +50°C	-10°C to +50°C	-10°C to +50°C
Installation	2 wires	3 wires	2 wires	2 wires
Mounting	Into mechanism box	Into mechanism box	Into mechanism box	Behind a push-button or inside junction box.
Protection type	IP 20	IP 20	IP 20	IP 20

Connection diagram

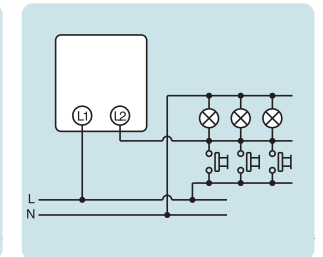
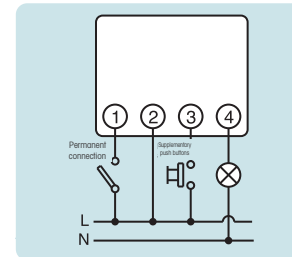
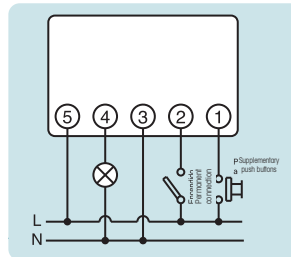
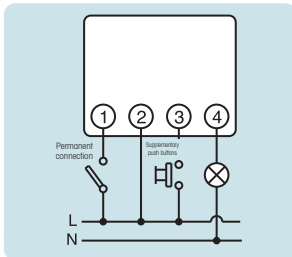

Dimensions

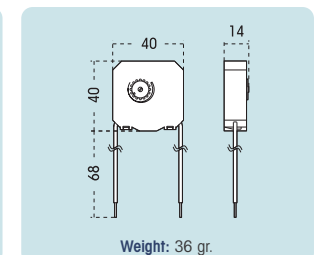
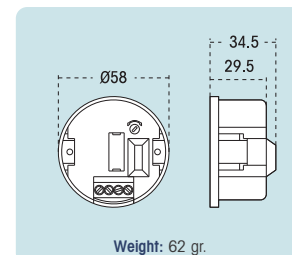
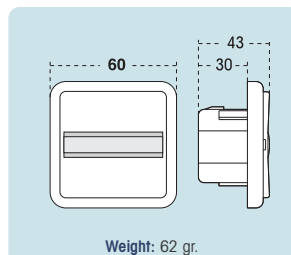
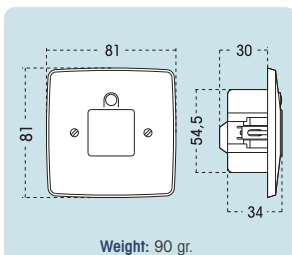

MOVEMENT SENSOR SWITCHES CLASSIFICATION

> WALL



ISIMAT

ISIMAT +

MULTIMAT

PROXIMAT

ORBIMAT

ECOMAT

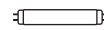
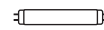
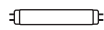
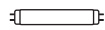
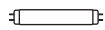

> Wall

Surface

Until 140°

★★

★★

★★

★★

★

Until 180°

★★

★★

★★

★★★

★

Until 200°

★★★

★★★

★★

★

Until 240°

★★★

★

Until 270° (*)

★★★

Internal or external corner

★★★

★★★

★★★

Into mechanism box

★★★

(*) In closed spaces (optimum in corridors, halls, etc. No suitable in garages, warehouses, etc.)

> CEILING

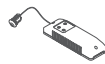

DICROMAT MICRO

DICROMAT MINI / DICROMAT 2 MINI

DICROMAT + / 2+ / DICROMAT +CR

CIRCUMAT / CIRCUMAT PRO CR

ECOMAT

MULTIMAT

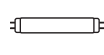

> Ceiling

Built-in

Halls

★★

★★★

★

Ø6m Areas

★★★

★★

Long corridors, internal and external corners and areas bigger than Ø6m

★

★★★

Surface

★★★

★★★

Hidden over ceiling

★★★



Outdoor



Outdoor under cover



Indoor



Suitable for fluorescent



Not suitable for fluorescent



Fluorescent By means of contactor

★

Suitable

★★

Recommended



★★★

Highly recommended

MOVEMENT SENSORS SELECTION

PRODUCT	Angle and Field of Detection	Maximum Load	Timing	Adjustment of Luminosity	Field of Detection Adjustment	Mounting Type	Technology	Type of Installation	Fluorescent and Low Consumption Lamps
ISIMAT +	200° 12m	1000W	3s-30min	2000 lux	-	Wall mounting	P.I.R.	Outdoor installation	Suitable for compensated fluorescent and low consumption
ISIMAT	140° 12m	1000W	3s-30min	2000 lux	-	Wall mounting	P.I.R.	Outdoor installation	Suitable for compensated fluorescent and low consumption
PROXIMAT	240° 12m	2000W	10s-10min	2000 lux	12m	Wall mounting	P.I.R.	Outdoor installation	Suitable for compensated fluorescent and low consumption
MULTIMAT	200° 12m	2000W	3s-30min	2000 lux	-	Ceiling mounting	P.I.R.	Outdoor installation	Suitable for compensated fluorescent and low consumption
ORBIMAT	195° 8m	40-400W	6s-12min	300 lux	8m	Wall mounting	P.I.R.	Indoor installation	Non suitable compensated fluorescent and low consumption
ECOMAT	360° Ø 6m	1000W	3s-30min	2000 lux	6m	Radio frequency technology	Radio frequency technology	Indoor installation	Suitable for compensated fluorescent and low consumption
CIRCUMAT	360° Ø 7m	1000W	3s-7min	300 lux	-	Ceiling mounting	P.I.R.	Indoor installation	Suitable for compensated fluorescent and low consumption
CIRCUMAT PRO CR	360° Ø 30m	2200W	3s-30min	1000 lux	30m	Ceiling mounting	P.I.R.	Indoor installation	Suitable for compensated fluorescent and low consumption
DICROMAT MICRO	360° Ø 4m	2000W	6s-12min	3000 lux	-	Wall mounting	P.I.R.	Indoor installation	Compensated fluorescent and low consumption via contactor
DICROMAT MINI / 2MINI	360° Ø 7m	2000W	DICR.+ : 6s-12min DICR.2+ : 1s-6s-12min T ₁ : 10s-30min	5 lux to ∞	7m	Wall mounting	P.I.R.	Indoor installation	Compensated fluorescent and low consumption via contactor
DICROMAT + / 2+ DICROMAT SENSOR + DICROMAT + CR / 2+ CR	360° Ø 7m	2200W	DICR.+ / +CR: 1s-10min DICR.2+ / 2+ CR: T ₁ : 1s-10min T ₂ : 10s-15min	DICR.+ / +CR: 2000 lux DICR.2+ / 2+ CR: T ₁ : 2000 lux T ₂ : 0 lux	7m	Wall mounting	P.I.R.	Indoor installation	Suitable for compensated fluorescent and low consumption

LEGEND

-  Angle and field of detection
-  Maximum load for incandescent lights (inquire if using other lights)
-  Timing
-  Adjustment of luminosity
-  Field of detection adjustment
-  Wall mounting
-  Ceiling mounting
-  Passive infrared technology
-  Radio frequency technology
-  Undercover, outdoor installation
-  Outdoor installation
-  Indoor installation
-  Suitable for compensated fluorescent and low consumption
-  Non suitable compensated fluorescent and low consumption
-  Compensated fluorescent and low consumption via contactor

ADVISE FOR INSTALLATION AND USE

- Avoid high reflective surfaces (mirrors, liquids, marble, etc.), elements with sudden temperature changes (heaters, air conditioning, draughts, etc.) or close to the lights.
- To avoid undesired activation, some models have detection field limiters.

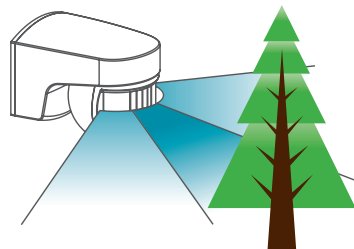

- The environment temperature where it is installed has a high influence on the field and distance of detection. The higher the temperature is, the less reliable the detection field becomes.

- The detection is performed when crossing the detection beams crosswise.

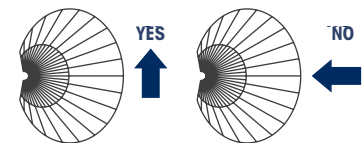

- To guarantee a better detection capacity when installing two detectors, we recommend superimposing the detection fields.

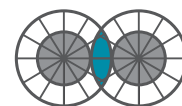

- The waves from ECOMAT can travel through any material, apart from metallic surfaces.

MOVEMENT SENSOR SWITCHES

ISIMAT / ISIMAT+



MULTIMAT



PROXIMAT



Description

Presence switches for the automatizing of light circuits in buildings, hotels, residences, offices, etc. Can be installed on the wall (flat, internal or external corner), on the ceiling (surface or built-in) or even hidden in the ceiling. Increased field of detection (up to 30 m. diameter) with CIRCUMAT by CR and possibility of programming by CR remote control.

Features

Angle	ISIMAT: 140°; ISIMAT +: 200°	200°	240°
Detection field	Forward: 12 m at 20°C Side: 8 m at 20°C	Forward: 12 m at 20°C Side: 8 m at 20°C	12 m at 20°C
Rated voltage	230 Va.c. / 50 Hz	230 Va.c. / 50 Hz	230 Va.c. / 50 Hz
Switching capacity	5 A / 230 Va.c. ~ cos φ = 1	10 A / 230 Va.c. ~ cos φ = 1	10 A / 230 V cos φ = 1
Maxim. recommended load			
Incandescent	1000 W	2000 W	2000 W
Compensated fluorescent	250 W	1000 W	1200 W
Low voltage halogen	500 VA	2000 VA	2000 VA
Halogen (230 Va.c.)	1000 W	2000 W	2000 W
Low consumption lamps	200 W	1000 W	900 W
LED	200 W	1000 W	1000 W
Adjustable parameters	Time and light sensitivity	Time and light sensitivity	Time, light sensitivity and field of detection
Temporization	3 s to 30 min.	3 s to 30 min.	10 s to 10 min. aprox.
Light sensitivity	5 - 30 - 2000 lux.	5 - 30 - 2000 lux.	5 - 30 - 2000 lux.
Operating temperature	-20°C to +40°C	-20°C to +40°C	-10°C to +40°C
Installation	Surface (on wall)	Surface (on wall or roof with connection base)	Surface (on wall: flat, internal or external corner)
Protection type	IP 55	IP 55	IP 45

Connection diagram

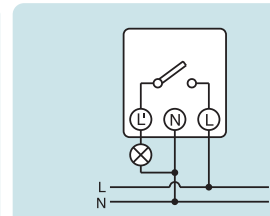
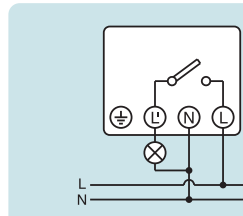
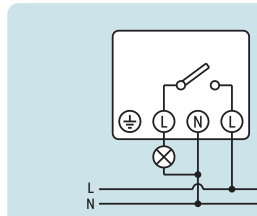

Dimensions

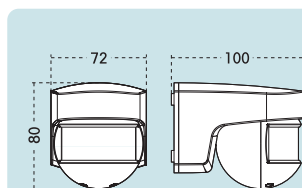

Weight: 195 gr.

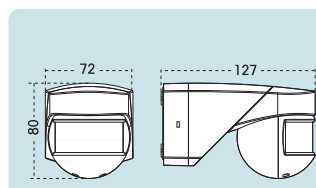

Weight: 275 gr.

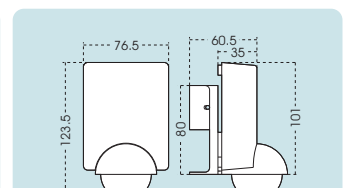

Weight: 353 gr.

MOVEMENT SENSOR SWITCHES

PRESENCE SWITCH

ORBIMAT



ECOMAT



CIRCUMAT



CIRCUMAT PRO CR



Description

Presence switches for the automatizing of light circuits in buildings, hotels, residences, offices, etc. Can be installed on the wall (flat, internal or external corner), built in on the mechanism box and on the ceiling (surface or hidden in the false plaster ceiling). Increased field of detection (up to 30 m. diameter) with CIRCUMAT PRO CR and possibility of programming by CR Remote Control.

Features

Angle	195°	270°	360°	360°
Detection field	0 to 8m at 20°C	1, 7 m height: From 0, 5 to 6 m forward and 3 m side	Up to 7 m diameter to 2, 5 m height at 20°C	Up to 30 m. of Ø to 3,5 m height Up to 20 m. of Ø to 2,5 m height
Rated voltage	230 Va.c. / 50-60 Hz	230 Va.c. / 50 Hz	230 Va.c. / 50-60 Hz	220 - 240 V c.c. / 50 Hz
Switching capacity	2 A / 230 Va.c. ~ cos φ = 1	6 A / 230 Va.c. ~ cos φ = 1	10 A / 230 Va.c. ~ cos φ = 1	10 A / 230 V cos φ = 1
Maxim. recommended load				
Incandescent	40 - 400 W	1000 W	1000 W	2200W
Compensated fluorescent	Not suitable	250 W	250 W	1200 W
Low voltage halogen	50 - 300 VA	500 VA	500 VA	2000 VA
Halogen (230 Va.c.)	18 - 400 W	1000 W	1000 W	2200 W
Low consumption lamps	Not suitable	200 W	200 W	1000 W
Downlight lamps	Not suitable	By means of contactor	400 W	900 W
LED	Not suitable	-	-	1000 W
Adjustable parameters	Time, light sensitivity and field of detection	Time, light sensitivity and field of detection	Time and light sensitivity	Time, light sensitivity and field of detection
Temporization	From 6 s to 12 min. approx.	From 3 s to 30 min.	From 3 s to 10 min. approx.	From 3 s to 30 min. approx.
Light sensitivity	5 - 300 - ∞ lux.	0, 5 - 2000 lux.	3 - 300 - ∞ lux.	5 to 1000 lux.
Operating temperature	-15°C to +45°C	0°C to +50°C	-20°C to +40°C	-
Installation	Mechanism box	Surface (on wall: flat, internal or external corner). Hidden over false ceiling	On ceiling up to 5 m. maximum height	On ceiling up to 10 m. maximum height
Protection type	IP 20	IP 20	IP 20	IP 44

Connection diagram

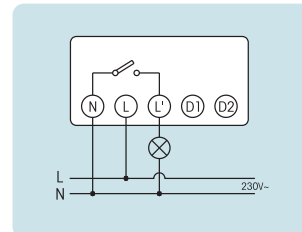
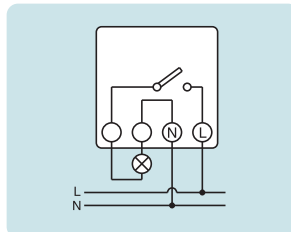
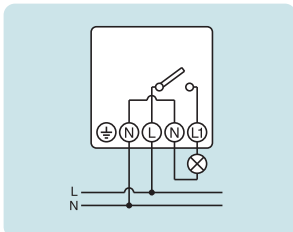
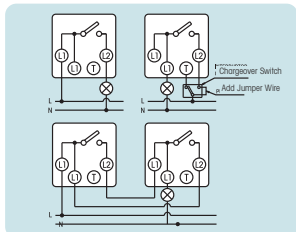

Dimensions

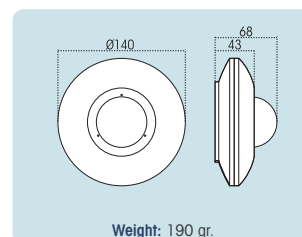
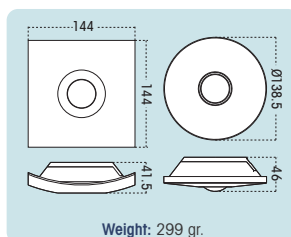
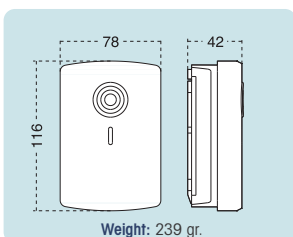
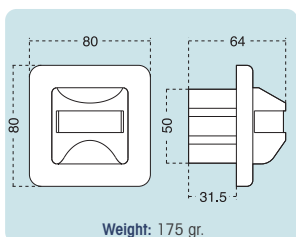

MOVEMENT SENSOR SWITCHES

DICROMAT MICRO



DICROMAT MINI DICROMAT 2 MINI



DICROMAT + / DICROMAT 2+ DICROMAT SENSOR +



DICROMAT + CR DICROMAT 2+ CR



Description

Presence switches for the automatizing of light circuits in buildings, hotels, residences, offices, etc. Mounted built in on the ceiling.

Manual programming or with remote control RC of the adjustable parameters in RC proximity detectors.

Features

Angle	360°	360°	360°	360°
Detection field	Up to 4 m diameter to 2, 5 m height	Up to 7 m diameter to 2, 5 m height	Up to 7 m diameter to 2, 5 m height	Up to 7 m diameter to 2, 5 m height
Rated voltage	230 Va.c. / 50 Hz	230 Va.c. / 50 Hz	230 Va.c. / 50 Hz	230 Va.c. / 50 Hz
Switching capacity	10 A / 230 Va.c. ~ cos φ = 1	T1: 10 A / 230 Va.c. ~ cos φ = 1 T2: 5 A / 250 Va.c. ~ cos φ = 1	DICROMAT +: 10 A / 230 Va.c. ~ φ = 1 DICROMAT 2+: 2 x 10 A / 230 Va.c. ~ φ = 1	DICROMAT + CR: 10 A / 230 V cos φ = 1 DICROMAT 2+ CR: 2x10 A / 230 V cos φ = 1
Maximum recommended load				
Incandescent	2000 W	T1: 2000 W	2200 W	2200 W
Compensated fluorescent	By means of contactor	By means of contactor	400 W	1200 W
Low voltage halogen	300 VA	300 VA	1000 VA	2000 VA
Halogen (230 Va.c.)	1000 W	1000 W	2200 W	2200 W
Low consumption lamps	By means of contactor	By means of contactor	400 W	1000 W
Downlight lamps	By means of contactor	By means of contactor	By means of contactor	900 W
LED	-	-	-	1000 W
Adjustable parameters	Time and light sensitivity	Time (T1 and T2) and light sensitivity (T1)	Time (T1 and T2), light sensitivity (T1) and field of detection (T1 and T2)	Time (T1 and T2), light sensitivity (T1) and field of detection (T1 and T2)
Temporization	T ₁ : from 6 s to 12 min.	DICROMAT MINI: T ₁ : from 6 s to 12 min. DICROMAT 2 MINI: T ₁ : from 6 s to 12 min. T ₂ : from 10 s to 30 min.	DICROMAT +: T ₁ : from 1 s to 10 min. DICROMAT 2+: T ₁ : from 1 s to 10 min. T ₂ : from 10 s to 15 min.	DICROMAT +CR: T ₁ : from 1 s to 10 min. DICROMAT 2+CR: T ₁ : from 1 s to 10 min. T ₂ : from 10 s to 15 min.
Light sensitivity	Adjustable from 5 Lux. Up to ∞	Adjustable from 5 Lux. to ∞	2 - 2000 lux.	2 - 2000 lux.
Operating temperature	-10°C to +45°C	-10°C to +45°C	-10°C to +45°C	-10°C to +45°C
Protection type	IP 20	IP 20	IP 20	IP 20

Connection diagram

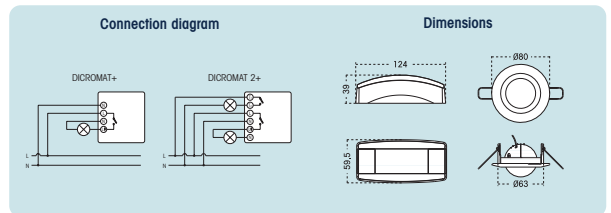
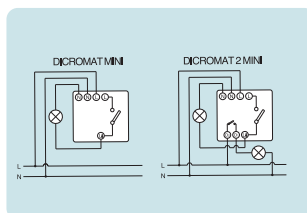
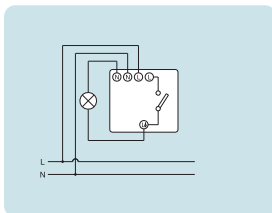

Dimensions

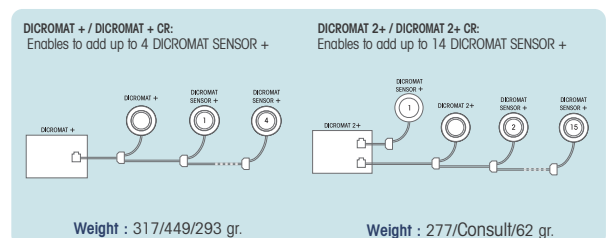
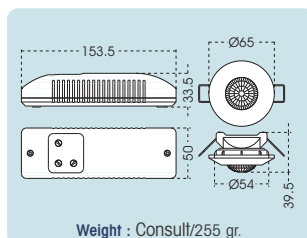
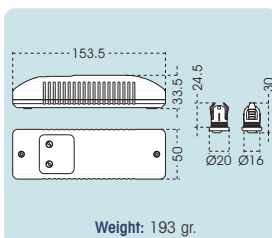



DOOR BELLS / HOUR COUNTERS

ORBISON

ORBISON DUO

CONTA EMPOTRABILE

CONTA MODULAR



> Description

Door bell with two musical notes, two versions: for one or two access to housing.

Hour counters for machinery and maintenance works, mounted in DIN rail or panel.

> Features

Rated voltage	230 Va.c. / 50-60 Hz 6, 12, 24 or 48 Va.c. /d.c.	230 Va.c. / 50-60 Hz 6, 12, 24 or 48 Va.c. /d.c.	24, 48, 110, 230 or 400 Va.c./50Hz from 12 to 80 Vd.c.	230 Va.c. / 50 Hz
Own consumption	-	-	3W max.	4W max.
Counting range	-	-	99999, 99 hours	99999, 99 hours
Accuracy	-	-	0, 01 hour	0, 01 hour
Musical notes	2	2 + buzzer	-	-
Installation	Surface	Surface	Panel mounting	DIN Rail
Protection type	-	-	IP 65	IP 20
Operating temperature	-	-	-20°C to +70°C	-10°C to +70°C

Connection diagram

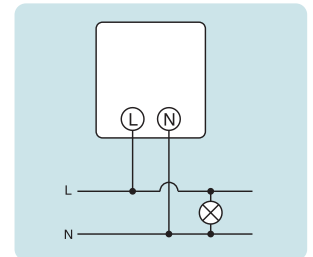
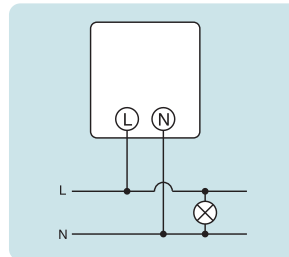
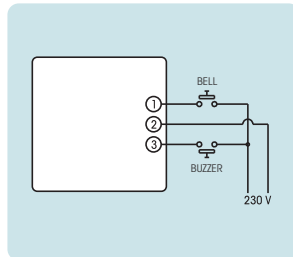
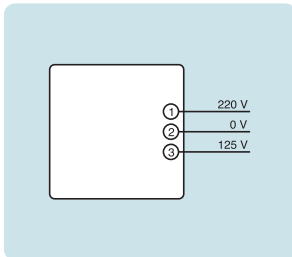

Dimensions

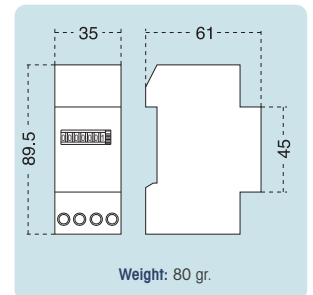
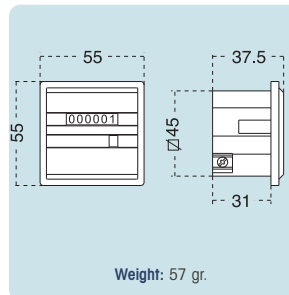
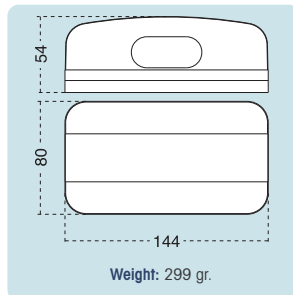
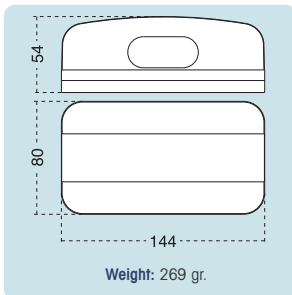

LEVEL CONTROL RELAY / PHASE DISCONNECTOR

EBR-1



EBR-2



FR12-1



> **Description**

They are designed for controlling the filling and emptying of water wells and tanks by means of probes

The mains disconnection switch disconnects the power supply once all series connected loads are turned off, thus preventing any electromagnetic interference fields from occurring.

> **Features**

Rated Voltage	230 Va.c.	230 Va.c. or 400 Va.c.	230 Va.c. Voltage control: 5 V-230 Vd.c. programmable
Frequency	50 - 60 Hz	50 - 60 Hz	-
Switching capacity	6(2) A 250 Va.c.	8 (2) A 230 Va.c. / 4 (1) A 400 Va.c.	16 A / 230 Va.c. $\sim \cos \varphi = 1$
Own consumption	3, 5 VA	4 VA	0, 8 W
Sensitivity	50 k Ω maximum	From 0 to 50 k Ω	5 mA-200 mA
Operating temperature	-10°C to +45°C	-10°C to +45°C	-10°C to +45°C
Protection Class	II according to EN 60335 under correct assembly conditions	II according to EN 60335 under correct assembly conditions	II according to EN 60335 under correct assembly conditions
Protection type	IP 20	IP 20	IP 20
Installation	DIN rail	DIN rail	DIN rail
Accessories	Optional: 3 probe set	Optional: 6 probes set	GLE 12-3: Special load accessory

Connection diagram

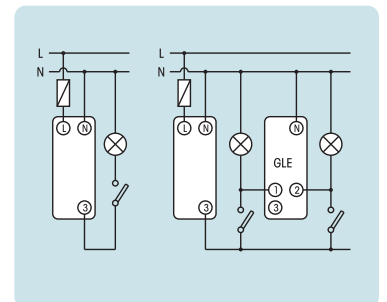
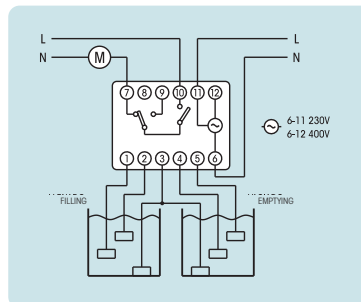
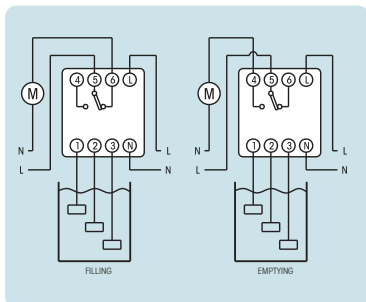

Dimensions

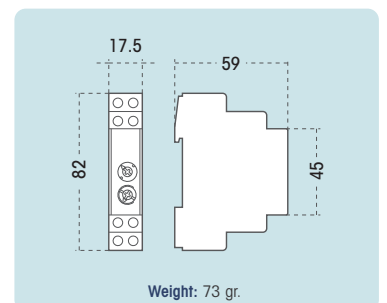
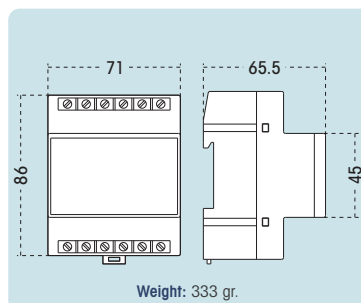
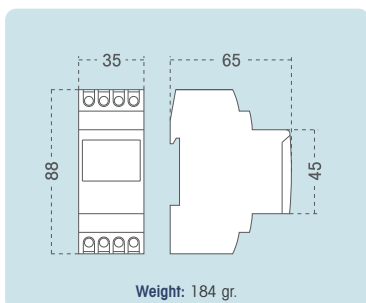

MEASUREMENT AND ENERGY

PÁG.26 | MODULAR SINGLE PHASE ENERGY METERS



CONTAX 2511 SO



CONTAX 2521 SO MID



CONTAX 3221 SO
CONTAX 3221 RF



CONTAX 6521 SO



CONTAX 0641 SO



CONTAX D-2221



CONTAX D-6331 SO

PÁG.28 | MODULAR THREE PHASE ENERGY METERS



CONTAX 0643 SO
CONTAX 0643i SO



CONTAX 0643 AR SO



CONTAX D-9703 SO



CONTAX NET

PÁG.29 | TARIFF ENERGY METER-SINGLE PHASE



MER B



MER



DOMOTAX



DOMOTAX TELEGEST PRIME

PÁG.31 | MULTIFUNCTION ENERGY METER-THREE PHASES



ORBITAX T3

PÁG.32 | ENERGY METER ACCESORIES / LOAD MANAGER



LECTOR OPTICO



ORBITEL



ADAPTADOR RS232/
RS485 A ETHERNET



SOFTWARE
DE LECTURA



ENERGEST 6051

MODULAR SINGLE PHASE ENERGY METERS

CONTAX 2511 SO

CONTAX 2521 SO MID

CONTAX 3221 SO CONTAX 3221 RF

CONTAX 6521 SO



> Description

Active single phase energy meters for individual consumption controlling in camp grounds, resorts, stands, marinas, etc. With communication possibility, DIN rail mounting. CONTAX 2511 SO MID complies with the european measuring instrument directive.

> Features

Reference voltage Un	230 Va.c. / 50-60 Hz	230 Va.c. / 50-60 Hz	230 Va.c. / 50-60 Hz	230 Va.c. / 50-60 Hz
Ib base current, (I maximum)	5 (25) A	5 (25) A	5 (32) A	10 (65) A
Rated voltage	195 to 253 V	195 to 253 V	195 to 253 V	195 to 253 V
Operating current	0, 02 to 25 A	0,25 to 25 A	0, 02 to 32 A	0, 04 to 65 A
Own consumption	0,5 VA aprox.	4 VA aprox.	7,5 VA aprox.(0,8 W)	7,5 VA aprox.(0,8 W)
Precision accuracy class	1	1	1	1
Numeric integrator	5 digits (kWh) + 1 decimal place (n x 0, 1 kWh)	5 digits (kWh) + 1 decimal place (n x 0, 1 kWh)	5 digits (kWh) + 1 decimal place (n x 0, 1 kWh)	5 digits (kWh) + 1 decimal place (n x 0, 1 kWh)
Pulse transmission	SO Type	SO Type	CONTAX 3221 SO: SO Type CONTAX 3221 ZIGBEE: Wireless by means of USB ZIGBEE accessory and software CONTAX ZIGBEE	SO Type
Recorded harmonics	Up to 7kHz	-	Up to 7kHz	Up to 7kHz
Operating temperature	-20 °C to +50 °C	-10 °C to +55 °C	-20 °C to +50 °C	-20 °C to +50 °C
Installation / Module numbers	DIN Rail / 1	DIN Rail / 2	DIN Rail / 2	DIN Rail / 2

Connection diagram

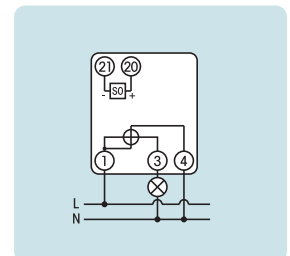
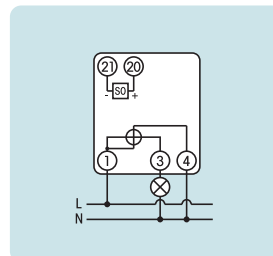
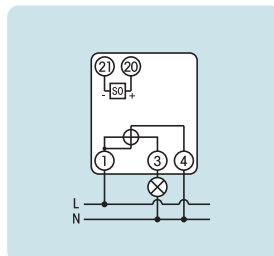
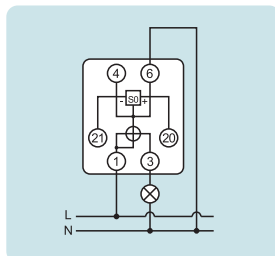

Dimensions

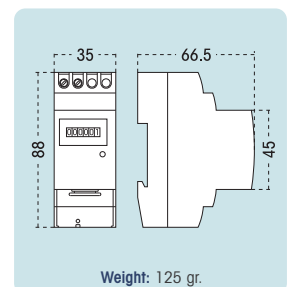
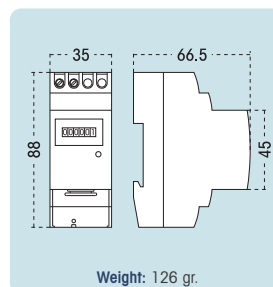
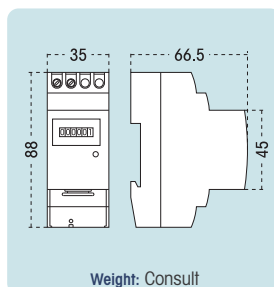
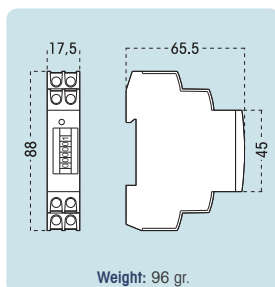

MODULAR SINGLE PHASE ENERGY METERS

CONTAX 0641 SO



CONTAX D-2221



CONTAX D-6331 SO



> Description

Active single phase energy meters for particular consumption controlling in camp grounds, resorts, stands, marinas, etc. With communication possibility, DIN rail mounting.

> Features

Rated voltage	230 Va.c. / 50-60 Hz	230 Va.c. / 50-60 Hz	230 Va.c. / 50-60 Hz
Ib base current, (I maximum)	5 (6) A	10 (22, 5) A	10 (63) A
Starting-up current with power factor = 1	15 mA	≤25 mA	40 mA
Own consumption	Voltage circuits < 2, 5 VA Current circuits < 2, 5 VA	4 VA	Voltage circuits < 2, 5 VA Current circuits < 2, 5 VA
Transformers ratio selection	Up to 1000/5 A	Direct connexion	Cable passage
Operating temperature	-10°C to +45°C	-10°C to +45°C	-10°C to +45°C
Relative humidity	95% maximum without condensation	10% to 90% without condensation	10 to 90% without condensation
Precision accuracy class	2	2	1
Numeric integrator	Mechanic 7 digits	Partial meter with reset: 5 digits Total meter: 7 digits	Partial meter with reset: 5 digits Total meter: 7 digits
Pulse transmission	S0 type	-	S0 type
Protection category	IP 20	IP 20 / IP51 in front	IP 20 / IP51 in front
Installation / Module numbers	DIN rail / 4	DIN rail / 2	DIN rail / 3

Connection diagram

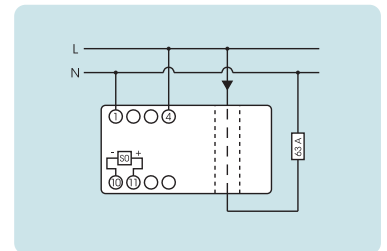
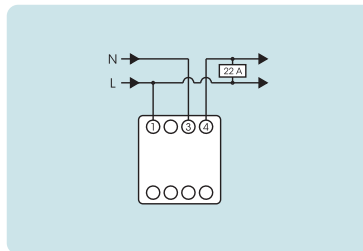
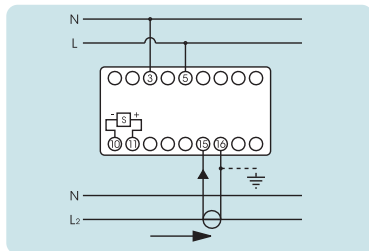

Dimensions

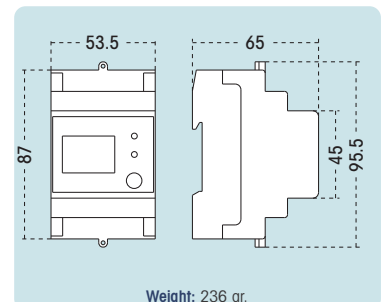
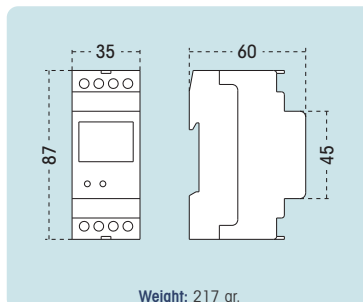
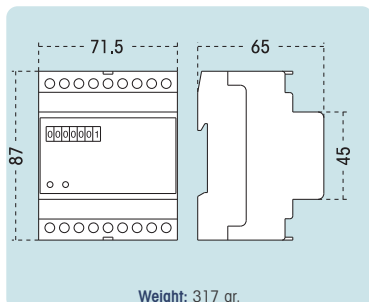

MODULAR THREE PHASE ENERGY METERS

CONTAX 0643 S0 / CONTAX 0643i S0



CONTAX 0643 AR S0



CONTAX D-9073 S0



PULSE COLLECTOR

CONTAX NET



Description

Active three phase energy meters for consumption controlling in machinery and installations. With communication possibility, DIN rail mounting.

Features

Rated voltage	3x230 (400) Va.c. / 50-60 Hz	3x230 (400) Va.c. / 50-60 Hz	3x230 (400) Va.c. / 50-60 Hz
Transformer ratio	Up to 1000/5 A	Up to 1000/5 A	Thread
Own consumption	Voltage circuits < 2, 5 VA Current circuits < 2, 5 VA	Voltage circuits < 2, 5 VA Current circuits < 2, 5 VA	< 2, 5 VA
Ib base current, (I maximum)	5 (6) A	5 (6) A	10 (90) A
Starting-up current with power factor = 1	15 mA	15 mA	40 mA
Operating temperature	-10°C to +45°C	0°C to +50 °C	-10°C to +45 °C
Relative humidity	95% maximum without condensation	10% to 90% without condensation	10% to 90% without condensation
Precision accuracy class	2	2 (Active) and 3 (Reactive)	1
Numeric integrator	Mechanic 7 digits	Mechanic 7 digits active/7 digits reactive	Partial meter with reset: 5 digits Total meter: 7 digits
Pulse transmission	S0 Type	S0 type	S0 type
Protection type	IP 20	IP 20	IP 20 / IP 51 in front
Installation / Module numbers	DIN Rail / 4	DIN Rail / 4	DIN Rail / 7

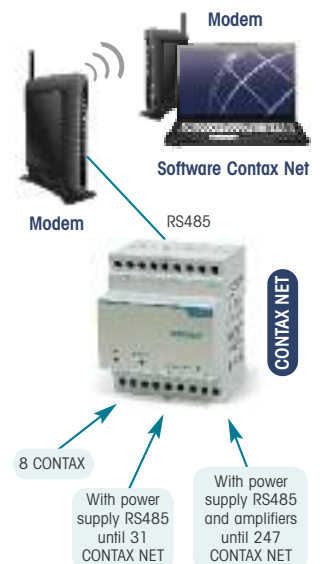

Connection diagram

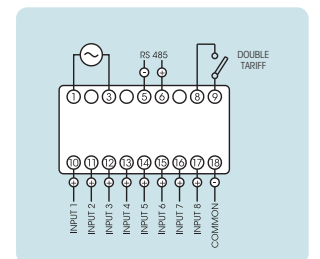
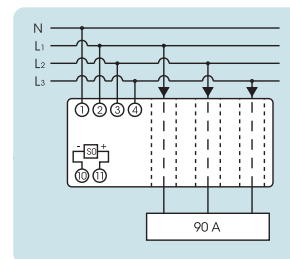
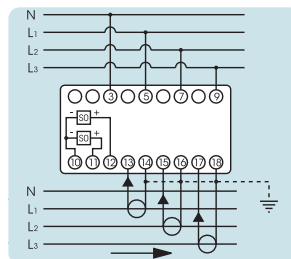
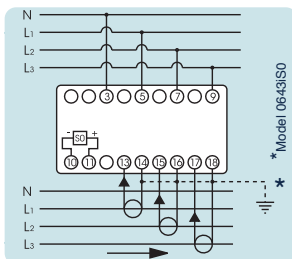

Dimensions

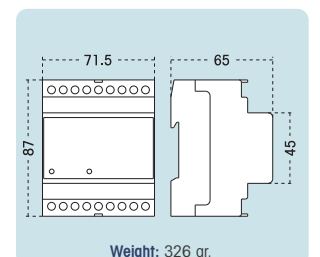
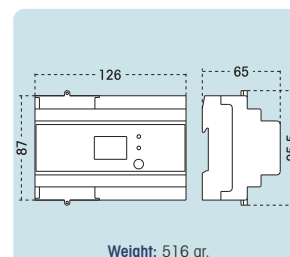
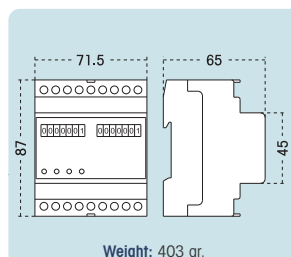
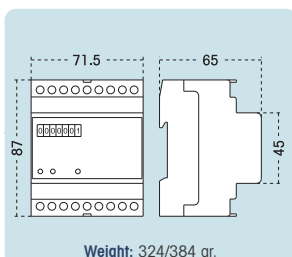

TARIFF ENERGY METER-SINGLE PHASE

MER b (DIGITAL AND ANALOGICAL)



The optimum solution for Household metering.

The MER B is an electronic meter for the measurement of active energy which allows the best cost/benefit ratio to be found for household meters. It provides the advantages of state-of-the-art electronic measurement technology. The meter has an LCD type display with large, clear digits.

The measurement of active energy is class B with stable behaviour throughout its curve. In order to be able to connect with AMR systems the meter has an optional pulse output, an RS485 interface and a comfortable auxiliary relay remotely.

Features

Tensión	120-220-230-240V
Current	5(40)A, 5(60)A, 10(100)A
Dielectric strenght	4kV 50 Hz
High voltage pulses	12 kv with source resistance of 2 Ohms (the IEC 62053 only requires 6 kv)
Display	Mechanical recorder digits are 6.7 mm high, LCD 10 mm high.
Temperature	-25 °C to +65°C
Optional pulse output	1600imp/kWh or 3200 p/kWh
Led for testing	1600 imp/kWh or 3200imp/kWh
Lifetime	15 years of certified life
Class	(IEC 62053)

Connection diagram

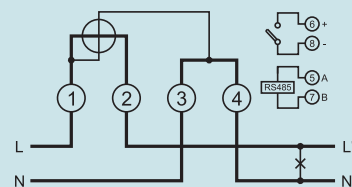

Dimensions

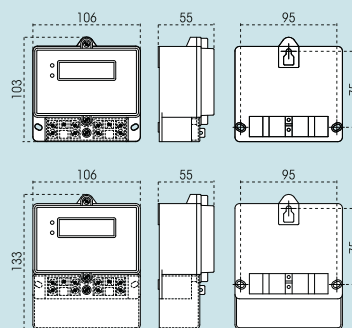

Weight: 395 gr.

MER



MER is an active energy meter; it is static single phase meter which means that it can substitute the import and export meter and the tariff time switch.

MER makes the direct measurement of active import energy, valid for time discrimination.

Period closing by means of button, 6 digit display.

Features

Reference voltage Un	230 Va.c.
Ib base current, (I maximum)	10 (60) A 15 (60) A
Frequency	50 Hz
Operating voltage	From 0, 5 to 1, 5 Un
Starting-up current	0, 2% Ib
Own consumption	Voltage circuits: 0, 7 W rated load Current circuits: 0, 3 W rated load
Precision class	2
Protection class	II according to EN60335
Protection type	IP 51
Installation	Fastening triangle
Periods	Up to two
Battery life	10 years

Connection diagram

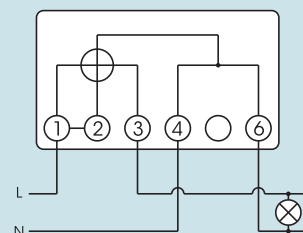

Dimensions

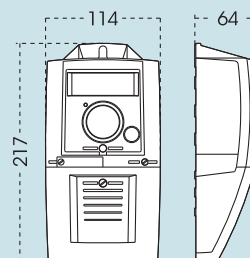

Weight: 835 gr.

MULTIFUNCTION ENERGY METER-SINGLE PHASE

DOMOTAX



There is also, a bidirectional model to measure the import and export energy in solar applications. From a basic model it is possible to add communication by RS232, RS485, SO pulse or pulse emissions (without voltage).

The RS485 is suitable for remote installations reading. It can be made with maximum delay / relay on demand. Therefore, it is a perfect energy meter in double tariff and solar applications.

Features

Reference voltage Un	230 Va.c.
Ib base current (Imax)	10 (60) A
Frequency	50 Hz
Operating voltage	from 0,8 to 1,1 Un
Starting-up current	40 mA (0.4% Ib)
Own consumption	Tension circuits: < 2VA Intensity circuits: < 1VA
Precision class	1
Protection class	II according to EN60335
Protection type	IP 51
Installation	Fixation triangle
Options	Communication port RS232 or RS485, SO pulse emitter, potential-free pulse emitter, retard relay and load curve

DOMOTAX is a multifunction, static, single phase energy meter for active (Class 1) or active/reactive energy, two wires direct connection. It is the ideal meter for daylight saving as it replaces the dual tariff meter and the time switch. It can carry out daylight saving for up to four charging periods with their corresponding maximeters.

There is also a bidirectional version for energy measurement both for imports and exports. DOMOTAX can substitute the import and export meter and the tariff time switch. Therefore, it can manage up to four periods with maxi meter.

Connection diagram

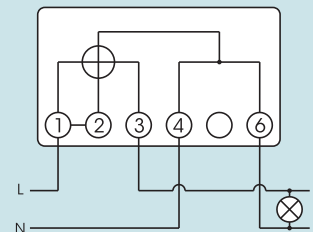

Dimensions

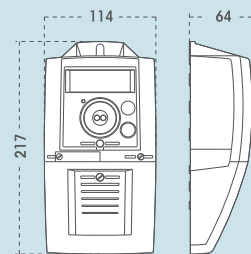

Weight: 969 gr.

DOMOTAX TELEGEST PRIME



Features

Voltage	230 V
Frequency	50 Hz
Precision class ACTIVE	Class B according to EN 50470-3
Precision class REACTIVE	Class 2 according to EN 62053-23
Base current	10 A
Maximum current	60 A
Operating temperature	-25 °C to +70 °C
Protection type	IP 51 according to EN 60529
PLC Communication	PRIME
Protection class	Class II

Description

Domotax Telegest Prime is a new monophasic static meter with PLC communication capacity and functions which allow its remote management with an DLMS protocol over PRIME for the measurement of active and reactive energy, direct connection and installation inside.

Connection diagram

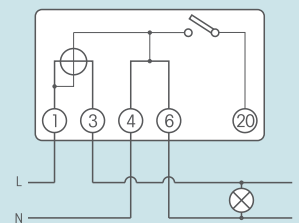

Dimensions

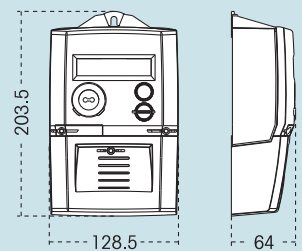

Weight: 919 gr.

ORBITAX T3



The ORBITAX T3 is a combined meter-recorder in a single piece of electronic equipment having electric power measurement and main analyser functions that comply with all EEC regulations and with the imposed specifications for applying various access tariff contracts, electronic signature and two load curves.

It uses the IEC 870-5-102 communications protocol adapted by the system operator.

The ORBITAX T3 performs the power measurement in four quadrants and can operate in unidirectional or bidirectional mode. It discriminates between CAPACI-

TIVE or INDUCTIVE when performing reactive energy measurements.

The meter measurement system is based on the very latest cutting-edge developments in power meters/digital watt meters. By digitising both voltage and current waveforms in three phases and employing digital calculations, r.m.s. values for voltage, current, active power, reactive power and power factor are obtained in addition to other electrical parameters.

The ORBITAX T3 also incorporates pulse transmitters and calibration LED. Communication with the ORBITAX T3 is achieved using an infrared port in accordance with EN 62056-21 (third edition EN 60107) which works with most optical collectors.

It also includes an RS-232 port, which can be replaced by RS-485 on order. These communications ports make use of RJ11 quick connections and permit modem communications in accordance with IEC 870-5-102.

Using a powerful software application, the ORBITAX T3 allows the display of real-time current, voltage, power, energy, power factor and frequency data on the computer screen, together with recording any excesses or defects in current, voltage, energy or power.

These characteristics make the ORBITAX an ideal meter for industrial installations and photovoltaic solar applications connected to the grid.

Technical Specifications

- Class 1 active energy and class 2 reactive energy.
- Class 0.5s active energy and class 1 reactive energy.
- Completely electronic system.
- Direct current measurement 10 (80) A or via a current transformer x/5 A.
- Active and reactive verification Led's.
- Alphanumerical LCD display.
- 8-digit power/maximum display. Programmable from 1 to 3 decimals.
- Maximum value recording for the last 12 periods, with date/time and applied tariff indications.
- Recording of the last 10 power failures (exceeding 0.5 seconds).
- Automatic or manual period closing (closed by button in the equipment) or in remote mode.
- Closing date/time indication.
- Optical communication port in accordance with EN 62056-2 (third edition of EN 60107).
- Factory-selectable optic-isolated communications port between RS232 and RS485.
- Relay analyser incorporated.
- It complies with IEC 870-5-102, adapted by the system operator.
- 3 simultaneous contracts.
- 3 and 6 period access tariff.

Models

Model	Precision	Characteristics
ORBITAX r4hCcl05T3	Class 0,5 s Active / Class 1 Reactive	V > 1000 V; 450 kW < Pc < 10 MW; x/110 V; x/5 A
ORBITAX r4hCcl10T3	Class 1 Active / Class 2 Reactive	V > 1000 V; 50 kW < Pc < 450 kW; x/110 V; x/5 A
ORBITAX r4hAcl10T3	Class 1 Active / Class 2 Reactive	V > 1000 V; 50 kW < Pc < 450 kW; x/5 A
ORBITAX r4hAcl10T3	Class 1 Active / Class 2 Reactive	V < 1000 V; 15 kW < Pc < 50 kW; x/5 A
ORBITAX d4hAcl10T3	Class 1 Active / Class 2 Reactive	V < 1000 V; 15 kW < Pc < 50 kW; Direct measure 10(80) A
ORBITAX d4hAcl10T3	Class 1 Active / Class 2 Reactive	V < 1000 V; Pc < 15 kW; Direct measure 10(80) A

Dimensions

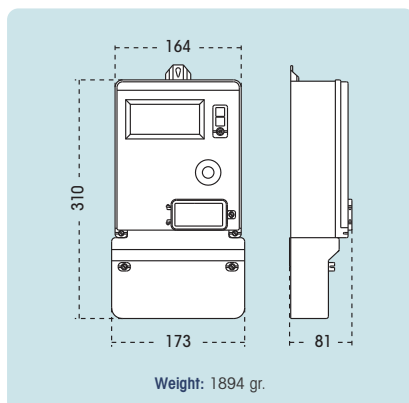

Connections

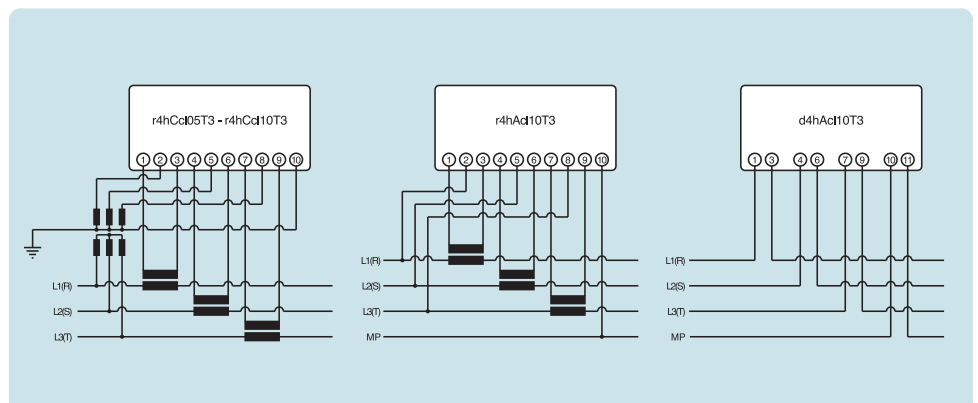

> MER - DOMOTAX – ORBITAX Accessories



Optical reader

This provides the option to easily connect a portable reader unit to the measuring equipment. The optic-coupling can be quickly, easily and safely carried out for the user using a computer USB port and connecting the optical reader to the meter optical port.

Modem ORBITEL RS232 / ORBITEL RS485

Allows remote reading and import of data from a meter with RS32 or RS485 port by GSM Modem. Consists of: PC connection cable, antenna, meter connection cable, modem and power supply.

* The operation of the equipment is subject to the characteristics of the GSM communication of the country. Consult.

RS232 to RS485 adapter

This permits the conversion of an RS232serial port into RS485 for reading several meters simultaneously. It includes a PC or modem RS-232 connection cable RS232-RS485 converter and power supply cable.

RS232/RS485 adapter to Ethernet and RS232/RS485 adapter to radiofrequency

This is an assembly for reading a meter with RS-232 output or a meter network with RS-485 output over an Ethernet 10/100 Base TX network. It can be installed on a DIN rail or surface. Industrial grade.

It works over a LAN and the Internet (TCP/IP).

The radiofrequency RS232/RS484 adapter allows remote reading of a meter network by frequency, i.e. without the need for complex wired network.

Read software

ITACA T3: automatic read software for ORBITAX T3.

AGNI: programmed read software for ORBITAX T3.

DOMOTAX: read software for DOMOTAX.

ENERGEST 6051



> Description

ENERGEST 6051 is a load management solution. Two relays control load activation and deactivation in function of general consumption and the maximum power set point established by the user. It is very useful for heating control divided into three sections, to prevent exceeding the contracted maximum power and guaranteeing 100% accumulator load. It also permits the display of current, voltage, active power, reactive power, $\cos \varphi$, active energy and frequency.

> Features

Rated voltage	230 Va.c. / 50-60 Hz
Ib base current, (I maximum)	60 A
Current measure	By means of transformer
Switching capacity	2 x 2 A 250 Va.c.
Relay functions	NO/NC configuration Current reference value Hysteresis value Load activation delay Sample period to connect the load
Accuracy	Voltage 0, 5% Current 1% Power 2% Frequency $\pm 0, 1$ Hz Active energy class 2

> Dimensions

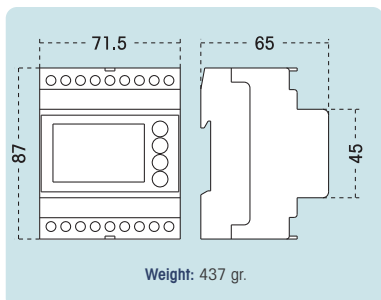

> Connection diagram

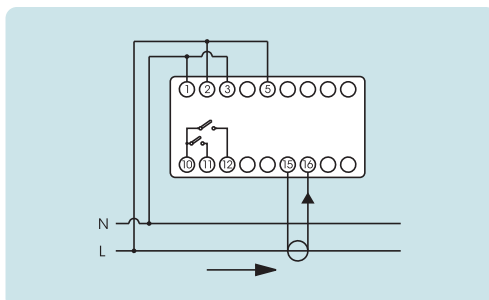

CLIMATE AND COMFORT

PÁG. 34 | ANALOGIC THERMOSTATS



CLIMA ML

CLIMA MLI

CLIMA MLW

CLIMA FANCOIL

PÁG. 35 | ELECTRONIC THERMOSTATS



LIV-A / LIVDN-B

NEO ML+

KLIO

PÁG. 36 | CRONOTHERMOSTATS



ERA

VIA

NEO

ORUS

THERMO X

ATHENA

NEO®/ KIT CLIMATIZACIÓN

PÁG. 38 | ACCESORIES



TX ATHENA

ATHENA TEMP

RX1 8A

RX4 8A

RX.ANT

X.TEMP 100K / X.TEMP 10K

PÁG. 39 | TELEPHONE CONTROLLERS



X.CODE WAVE

X.CODE GSM

MA 16

CODITEL

ANALOG THERMOSTATS

CLIMA ML

CLIMA MLI

CLIMA MLW

CLIMA FANCOIL



Description

ANALOG thermostats for air-conditioning and heating systems. Functioning by gas membrane, which guarantees a long accuracy life. Power supply is not necessary.

Features

Rated voltage	Not necessary	Not necessary	Not necessary	Not necessary
Switching capacity	16 (2,5) A / 250 V	10 (1,5) A / 250 V	10 (1,5) A / 250 V	10 (1,5) A / 250 V
Manual control	-	ON/OFF + Neon indicator	Heating/air conditioning	Heating/Off/Air conditioning Speed 1 / Speed 2
Temperature range	5 °C to 30 °C	5 °C to 30° C	5 °C to 30 °C	5 °C to 30 °C
Functioning temperature	0 °C to 50 °C	0 °C to 50 °C	0 °C to 50 °C	0 °C to 50 °C
Protection class	II according to EN 60335 under correct assembly conditions	II according to EN 60335 under correct assembly conditions	II according to EN 60335 under correct assembly conditions	II according to EN60335 under correct assembly conditions
Protection type	IP 20	IP 20	IP 20	IP 20
Installation	Surface	Surface	Surface	Surface
Features	Room thermostat with small and compact design, high accuracy. Changeover contact.	Room thermostat with small and compact design, high accuracy. Changeover contact with on/off manual switch.	Room thermostat with a changeover contact and heating/air conditioning manual switch with on/off manual control. Therefore it is not necessary to manipulate the temperature selector to change between air conditioning and heating.	Room thermostat for Fancoil systems with 2 speeds selected by manual switch. Valid for heating and air conditioning systems.

Connection diagram

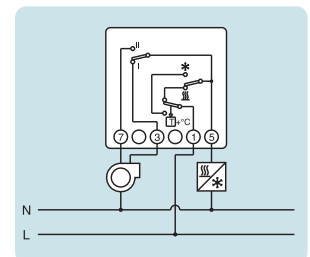
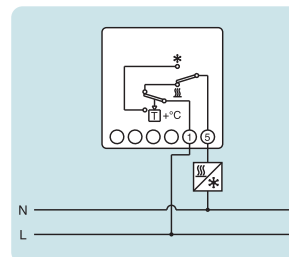
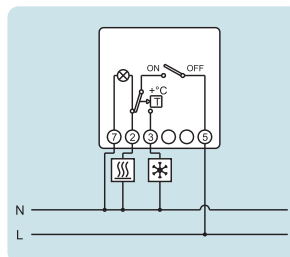
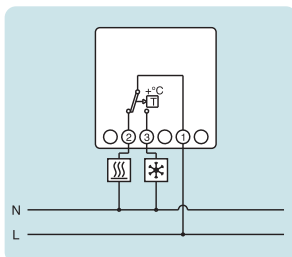

Dimensions

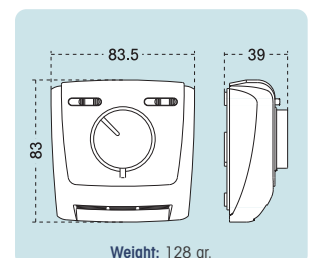
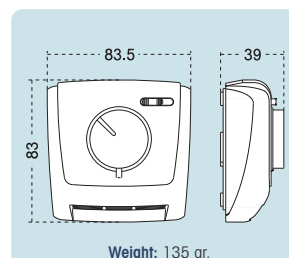
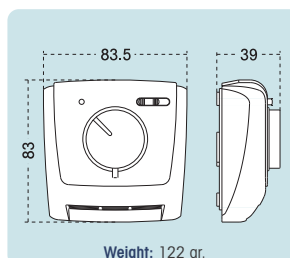
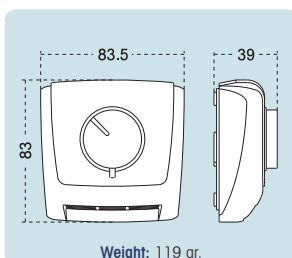

ELECTRONIC THERMOSTATS

LIV-A / LIV-DN-B



NEO ML



KLIO



Description

Range of electronic thermostats to control air conditioning systems. NEO is designed to control under floor heating through tube. KLIO enables telephone control (X.CODE WAVE or X.CODE GSM) and wireless connection with the air conditioning or heating machine by means of TX ATHENA and RX1 8A.

Features

Rated voltage	LIV-A: 230 Va.c. - 50/60 Hz LIV-DN-B: 2 alkaline batteries 1, 5 V AAA	2 alkaline batteries 1, 5 V AAA (LR03)	2 alkaline batteries 1, 5 V AAA (LR03)
Switching capacity	8(5) A / 250 Va.c.	5(1) A / 250 Va.c.	8 A / 250 Va.c.
Battery life	1 year (LIV-DN-B)	1 year approximately	1 year approximately
Temperature measurement accuracy	-	± 0, 5 °C	± 0, 5 °C
Night temperature	D/N: -3 °C Day Temp.	Adjustable	Adjustable from 2 °C to 35 °C
Anti ice temperature	-	-	Adjustable from 0 °C to 15 °C
Temperature resolution	-	0, 1 °C	0, 1 °C
Temperature regulation	5 °C to 35 °C approx.	Internal probe: 5 °C to 35 °C External probe: 5 °C to 45 °C	2 °C to 35 °C approx.
Operating temperature	0 °C to +50 °C	-10 °C to +50 °C	0 °C to +50 °C
Protection class	II according to EN 60335 under correct assembly conditions	II according to EN 60335 under correct assembly conditions	II according to EN 60335 under correct assembly conditions
Protection type	IP 40	IP 40	IP 40
Installation	Surface or over mechanism box	Surface or over mechanism box	On wall (horizontal or vertical)
Accessories	-	X.TEMP 10K	TX ATHENA, X CODE WAVE, X CODE GSM, MA 16, XR1 8A, RX.ANT
Features	LIV-DN-B: Night temperature selector with a reduction of 3°C.	Summer and winter operating mode. Night temperature selector.	Summer and winter operating mode. Night temperature selector. Adjustable in time and °C.

Connection diagram

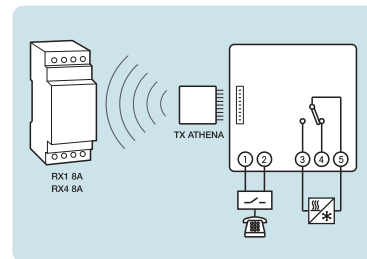
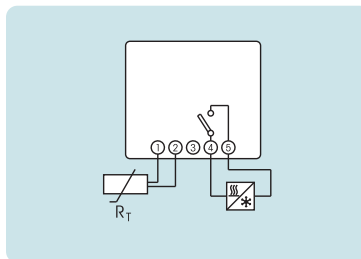
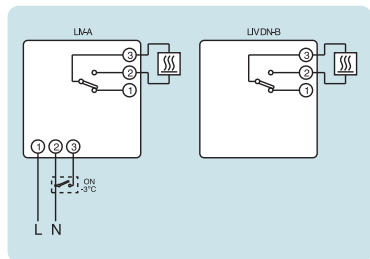

Dimensions

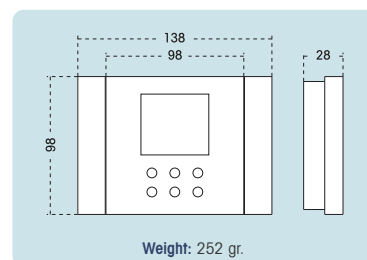
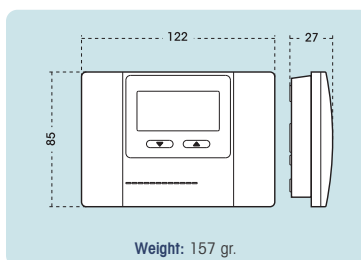
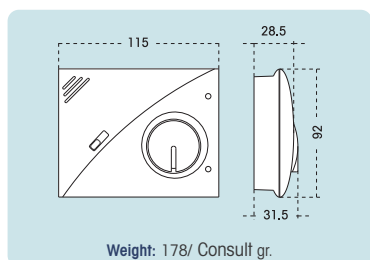

CRONOTHERMOSTATS

ERA



VIA



NEO



ORUS



Description

Cronothermostat to control air conditioning or heating installations. ANALOG (ERA) or digital versions. It admits phone controllers (X.CODE GSM or X.CODE WAVE). NEO and VIA are available in different colours (black, white and aluminium).

Features

Rated voltage	2 alkaline batteries 1, 5 V AA (LR06)	2 alkaline batteries 1, 5 V AAA (LR03)	2 alkaline batteries 1, 5 V AAA (LR03)	1 alkaline batteries 1,5V AA (LR06)
Battery substitution time	-	10 minutes	10 minutes	1 minute
Switching capacity	5(1) A / 250 Va.c.	5(1) A / 250 Va.c.	5(1) A / 250 Va.c.	8 A / 250 Va.c.
Contact	Changeover	Changeover	Changeover	Changeover
Battery lie	1 year approximately	1 year approximately	1 year approximately	1 year approximately
Minim. programmable time	15 min. (Daily)	1 hour	30 min.	1 hour
Temperature accuracy	± 1 °C	$\pm 0, 2$ °C	$\pm 0, 5$ °C	$\pm 0, 5$ °C
Resolution	-	0, 1 °C	0, 1 °C	0,1 °C
Temperature measurement period	1 minute	1 minute	30 s	Every 20 seconds
Output relay updating	1 minute	1 minute	1 minute	1 minute
Programming type	Daily	Weekly 8 programs / 2 temperatures + Anti ice	Weekly 8 programs / 2 temperatures + Anti ice	Weekly 7 programs / 5 programmable temperatures
Temperature range	10 °C to 40 °C (Comfort) 0 °C to 25 °C (Saving)	15 °C to 35 °C (Comfort) 5 °C to 25 °C (Saving)	0 °C to 50 °C (with internal probe) -10 °C to +50 °C (with external probe)	0 °C to 50 °C (with internal probe) -40 °C to 60 °C (with external probe)
Operating temperature	-10 °C to 45 °C	0 °C to 50 °C	0 °C to 50 °C	-40 °C to 60 °C
Operating accuracy	-	$\leq \pm 1, 2$ s. / 24 h to 23°C	$\leq \pm 1, 2$ s. / 24 h to 23°C	-
Protection class	II according to EN 60335 under correct assembly conditions	II according to EN 60335 under correct assembly conditions	II according to EN 60335 under correct assembly conditions	-
Protection type	IP 40	IP 40	IP 40	IP 40
Installation	Surface	Surface or over mechanism box	Surface or over mechanism box	Surface or over mechanism box
Accessories	-	X CODE WAVE, X CODE GSM, MA 16.	X CODE WAVE, X CODE GSM, MA 16, X TEMP 100K	X.CODE GSM, MA 16, X.TEMP 100K

Connection diagram

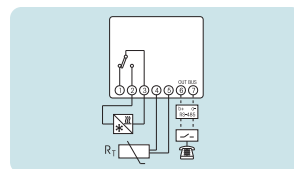
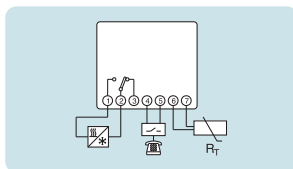
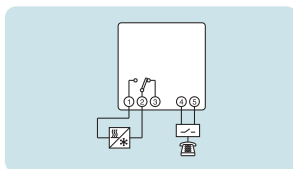
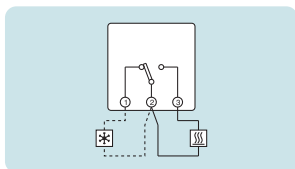

Dimensions

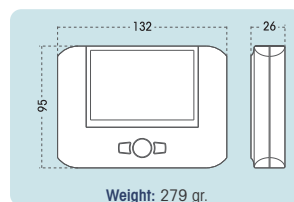
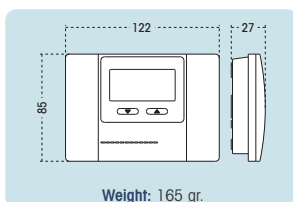
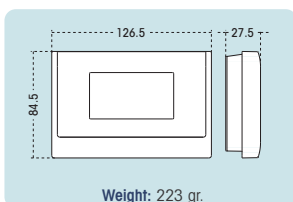
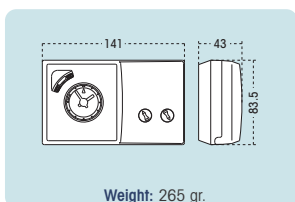

THERMO X



ATHENA



NEO^{RF} / KIT CLIMATIZACIÓN



Description

THERMO X is a weekly electronic cronothermostat which combines simplicity of use with functional innovation, making it an excellent domestic temperature regulators.

ATHENA enables the acclimatization control for up to four different areas by means of extra probes (ATHENA TEMP) connected by BUS cable. It can be connected without cables (TX ATHENA) with the actuator RX4 8A; admits phone controller (X.CODE WAVE or X.CODE GSM).

The NEO^{RF} kit is the easiest way to control the acclimatization by means of a wireless solution. It is made up of a plug in actuator for the heater, a NEO^{RF} cronothermostat and an optional external probe.

Features

Rated voltage	2 alkaline batteries 1,5 V AA (LR06)	2 alkaline batteries 1, 5 V AAA (LR03)	2 alkaline batteries 1, 5 V AAA (LR03)
Battery substitution time	-	2 minutes	10 minutes
Switching capacity	8 A / 250 Va.c.	8 A / 250 Va.c.	5(1) A 250 Va.c.
Contact	Changeover	Changeover	Changeover
Battery life	2 years approximately	1 year approximately	1 year approximately
Minimum programmable time	1 hour	30 min.	30 min.
Temperature accuracy	± 0,5 °C	± 0, 5 °C	± 0, 5 °C
Resolution	0,1 °C	0, 1° C	0, 1 °C
Temp. measurement period	-	30 seconds	30 seconds
Output relay updating	-	-	1 minute
Programming type	Weekly with 7 programs / 3 temperatures	Weekly with 7 daily programs/ 4 temperatures	Weekly with 8 daily programs/ 2 temperatures + anti ice
Temperature range	2 °C to 35 °C (heating automatic/manual) 10 °C to 35 °C (air conditioning automatic/manual) -40°C to 60°C (with external probe)	2 °C to 35 °C approx. -40°C to 60°C (with external probe)	0 °C to 50 °C (internal probe) -10 °C to +50 °C (external probe)
Operating temperature	0 °C to 50 °C	0 °C to 50 °C approx.	0 °C to 50 °C
Protection class	II according to EN 60335 under correct assembly conditions	II according to EN 60335 under correct assembly conditions	II according to EN 60335 under correct assembly conditions
Protection type	IP 40	IP 40	IP 40
Installation	Surface or over mechanism box	Surface or over mechanism box	Surface or over mechanism box
Accessories	X.CODE WAVE, X.CODE GSM, MA 16, X.TEMP 100K.	X CODE GSM, X CODE WAVE, MA 16, X TEMP 100K, TX ATHENA, ATHENA TEMP, RX1 8A, RX4 8A, RX.ANT	X.TEMP RF and RF system plug-in signal repeater

Connection diagram

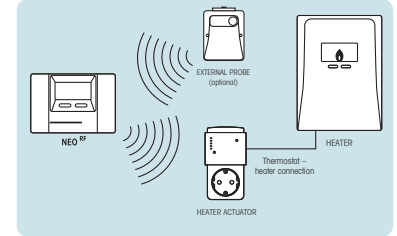
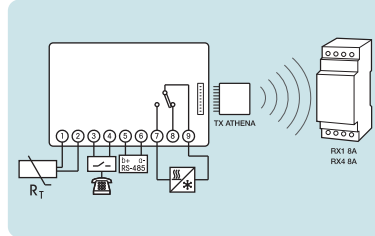
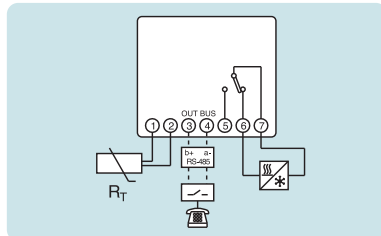

Dimensions

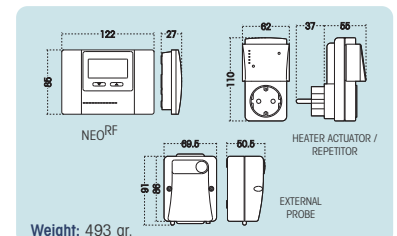
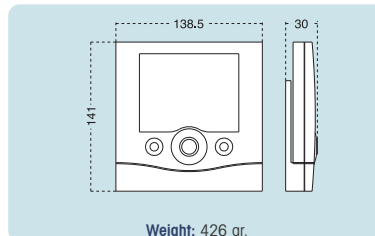
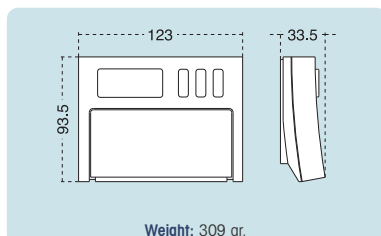

TX ATHENA



ATHENA TEMP



RX1 8A



RX4 8A



Features

Definition	It converts the thermostat KLIO or the cronothermostat ATHENA in wireless transmitters.	Programmable temperature probe used to control different areas by means of ATHENA.	Waves actuator with one output, for KLIO or ATHENA. It receives the TX ATHENA signal. RX.ANT antenna included.	Waves actuator with four outputs for ATHENA. It receives the TX ATHENA. RX.ANT antenna included.
Rated voltage	-	2 Alkaline batteries 1, 5 V AAA (LR03).	230 Va.c.	230 Va.c.
Output control	-	-	1 Changeover relay 8 A/250 Va.c.	3 Changeover relays and 1 NA relay 8 A / 250 Va.c.
Installation	Inserted into KLIO or ATHENA.	Surface	DIN rail	DIN rail
Connection diagram	<p>Wireless connection</p> <p>Weight: 31 gr.</p>	<p>Zone control</p> <p>Weight: 139 gr.</p>	<p>Wireless connection</p> <p>Weight: 175 gr.</p>	<p>Zone control</p> <p>Weight: 639 gr.</p>

RX.ANT



X.TEMP 100K



X. TEMP 10K



Features

Definición	External antenna for RX1 8A or RX4 8A.	NTC external temperature probe (100 k at 25°C) for THERMO X, NEO, ATHENA y ORUS	NTC external temperature probe (10kΩ to 25°C) for NEO ML+
Frequency	433, 92 ±10 MHz.	-	-
Impedance	50 Ω	-	-
Cable length	4, 5 meters.	2 metres (extendable to 40 metres) and 1 mm ² .	4 meters (up to 40 meters) and 1mm ² .
Operating temperature	-	-40 °C to +60°C	-40 °C to +60°C
Protection class	-	IP 66	IP 66



TELEPHONE CONTROLLERS

X.CODE WAVE



X.CODE GSM



MA 16



CODITEL



> Description

They enable to act in the acclimatization installation by means of mobile or land telephone line.

> Features

Definition	Device for the ON/OFF remote control by means of land telephone line.	GSM telephone controller for the ON/OFF control by means of SIM card. It is possible a BUS connection with the cronothermostat for individual areas control. To be used with any mobile phone operator.	Connected with X.CODE GSM, X.CODE WAVE and CODITEL it enables controlling loads up to 16 A.	CODITEL is a phone remote control that reacts to the missed call when an authorized user makes a call, Coditel works (opens the garage door, turns on the boiler, garden sprinkler or any other electrical circuit) without picking up; and hence the mobile phone becomes a remote control at no charge.
Features	Rated voltage: 230 V.a.c. / 50 Hz 1 output relay (0,5 A - 125 V.a.c.). For 16 A use MA16. ON/OFF manual control and indicator led. Telephone cable included to connect with the telephone line. Mounting on surface or over mechanism box. * The operation of the equipment is subject to the characteristics of the GSM communication of the country. Consult.	Rated voltage: 230 V.a.c. / 50 Hz 1 output relay (5 A - 230 V.a.c.). For 16 A use MA16. Manual control ON/OFF and indicator led. Mounting on surface or over mechanism box. * The operation of the equipment is subject to the characteristics of the GSM communication of the country. Consult.	Rated voltage: 250 V.a.c. (-15% / +10%) Output: mechanic relay 16 A / 250 V with contact "Normally Close" (NC). DIN rail mounting.	Power supply: 230 V.c.a. / 50 Hz 1 output control relay (5a-230 V.c.a.) Coditel carries out ON, OFF, time delayed ON and time delayed OFF or change in status operations as regards the output relay by way of missed calls or SMS. It can also send an SMS message in reply with the installation status. Allows 100 different users. Accessory: GSM ANTENA with 3 m of cable to improve coverage in metallic cabinets, low signal etc.. * The operation of the equipment is subject to the characteristics of the GSM communication of the country. Consult.

Connection diagram

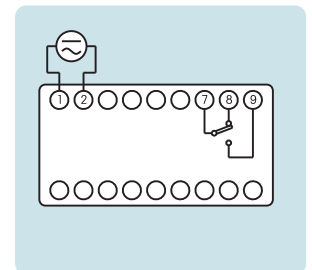
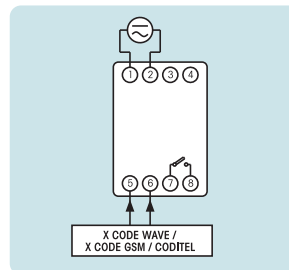
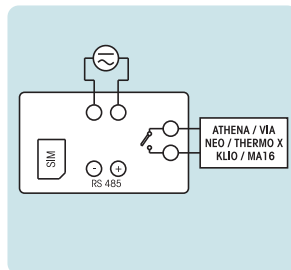
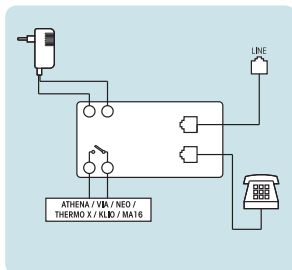

Dimensions

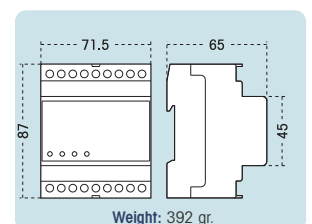
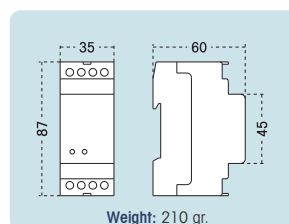
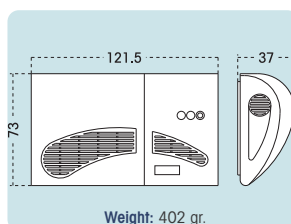
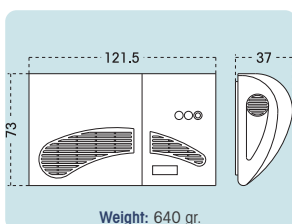



GAS DETECTOR

TWIST



> Description

TWIST is a wall mounted gas detector by means of catalytic sensor. The TWIST gives an acoustic and visual warning of any gas leaks. TWIST also has an internal relay which can be connected to a normally open "NO" or normally closed "NC" shut off valve relay in order to cut off the flow of gas once a leak has been detected.

> Functioning

- Auto check with fault indication.
- The unit activates when it detects a gas concentration of 10% of the L.E.L. (Lower Explosive Limit).
- After powering up the gas detector, there is a 1 minute delay before the system is active.
- After detecting gas for a 20 seconds period, the acoustic alarm and shut OFF valve relay are activated.

> Kit Twist + Shut Off Valve Relay

- Gas detector TWIST.
- Shut OFF valve normally open suitable for 1/2" or 3/4" pipe. (Consult for other contact configuration or different pipe).

> TWIST

Product code	Model
OB514410	TWIST METHANE-TOWN GAS
OB514510	TWIST GLP (Propane, butane)
OB514610	TWIST CO (Check availability)

> KIT TWIST + ELECTROVALVE

Product code	Model
OB515212	KIT GAS METANE-TOWN GAS 1/2"
OB515312	KIT GAS GLP (Propane, butane) 1/2"
OB515234	KIT GAS METANE-TOWN GAS 3/4"
OB515334	KIT GAS GLP (Propane, butane) 3/4"

> Features

Power supply	230 Va.c. 50 Hz
Capacity of contacts	Changeover 2, 5 A / 230 V
Absorption	20 mA max
Operating temperature	-5°C to +40°C
Relative humidity	-30% -90%
Acoustic signal	85 dB (A) at 1m.
Type of protection	IP 42
Installation	Wall or box mounting

> Dimensions

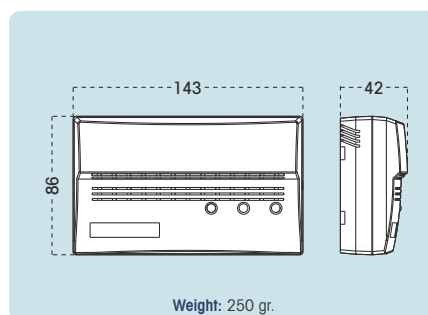

> Connection diagram

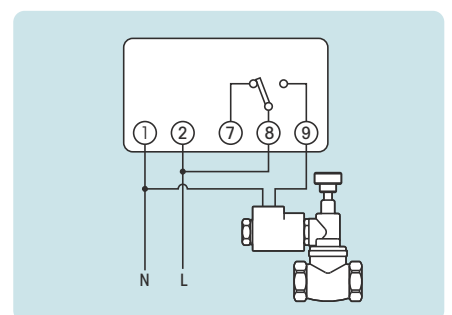

STREET LIGHTING

PÁG. 42 | TWILIGHT SWITCHES



VEGA



DOMOLUX



ORBIFOT

PÁG. 43 | ASTRONOMIC SWITCHES



ASTRO



DATA ASTRO



ASTRO NOVA CITY



ASTRO UNO



ASTRO LOG



ASTRO SAT

PÁG. 45 | LIGHT FLOW STABILIZERS DIMMERS



ESDONI-EN



ESDONI-SN



ESDONI-M

PÁG. 49 | LIGHTING REMOTE MANAGEMENT SYSTEMS



XEO LUM MODULAR

PÁG. 50 | REMOTE MANAGEMENT SYSTEMS FOR ELECTRICAL BOARDS



ORBICOM / NODITEL



TWILIGHT SWITCHES

VEGA



DOMOLUX



ORBIFOT



> Description

ON and OFF switching controllers according to the luminosity level, it is used in lighting installations such as shop windows, doorways, signalling, neon signs, etc.

> Features

Rated voltage	230 Va.c.	230 Va.c.	230 Va.c. Other voltages, consult
Frequency	50 Hz	50-60 Hz	50 Hz
Switching capacity	10 A / 230 Va.c. $\cos \varphi = 1$	16 A / 230 Va.c. $\cos \varphi = 1$	10 A / 250 Va.c. $\cos \varphi = 1$
Own consumption	8 VA (1 W approx.)	3, 4 VA (0, 7 W approx.)	8 VA (1 W approx.)
Contact type	Single with voltage	Single with voltage	Single without voltage
Maximum recommended loads			
Incandescent	2000 W	3000 W	800 W
Non-compensated fluorescent	200 W	1000 W	360 W
Fluorescents	200 W	1000 W 120 μ F	By means of contactor
Low voltage halogen	500 VA	2000 VA	600 VA
Halogen (230 Va.c.)	1000 W	3000 W	800 W
Low consumption lamps	200 W	600 W (30 x 20 W)	By means of contactor
Sensor type	Cadmium Sulphurate	Cadmium Sulphurate	Cadmium Sulphurate
Operating temperature	-30 °C to +50 °C	-25 °C to +45 °C	-10 °C to +50 °C
Sensitivity	5-300 lux logarithm	5-200 lux logarithm	5-1000 lux logarithm
ON/OFF delay	60 s / 60 s	30 s / 30 s	25 s / 25 s
Protection type	IP 54	IP 55	IP 65
Installation	Surface or post	Surface or post	Surface or over lamp post

Connection diagram

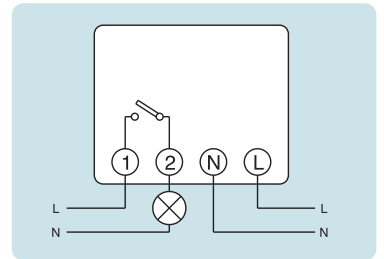
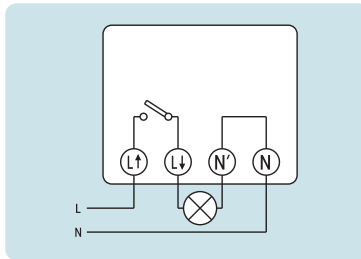
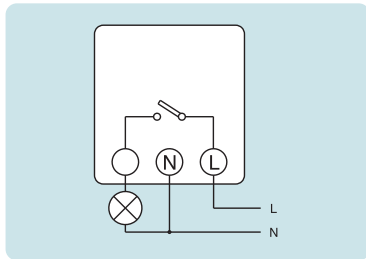

Dimensions

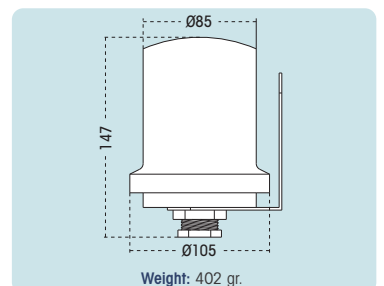
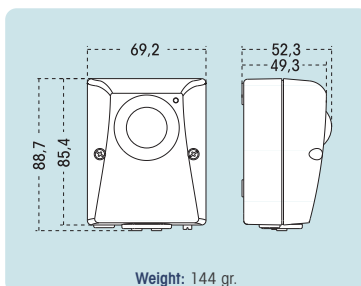
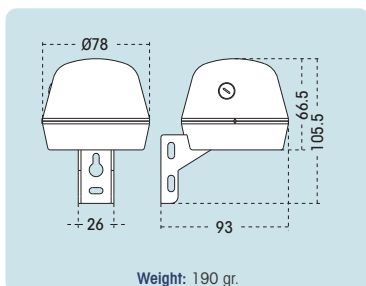



ASTRONOMIC SWITCHES

ASTRO



DATA ASTRO



ASTRO NOVA CITY



> Description

Time switches for exterior lighting installations. They automate the on and off time control for the lighting circuits in line with daylight hours in the area where it is installed. Economic saving on installation, maintenance and consumption.

> Features

Rated voltage	120 or 230 Va.c. / 50-60 Hz	120 or 230 Va.c. / 45-60 Hz	230 Va.c. / 50-60 Hz
Switching capacity	2x10(2) A / 250 Va.c.	2x10 (2) A / 250 Va.c.	2x16 (10) / 250 Va.c.
Contact type	Automatic: single with voltage Voluntary: changeover without voltage	Changeover without voltage	Changeover without voltage
Accuracy	≤ 0, 5 s/day between 20 °C and 30 °C	≤ 1 s/day between 20 °C and 30 °C	≤ 1s/day at 23 °C
Battery back up	≥ 12 years without power supply at 23 °C	≥ 30 days after 48 h. connected to the power supply uninterrupted	≥ 4 years without power supply (Lithium)
Maximum recommended loads	-	-	-
Incandescent	-	2000 W	3000 W
Fluorescents	-	By means of contactor	1200 W
Low voltage halogen	-	1500 VA	2000 VA
Halogen (230 Va.c.)	-	2000 W	3000 W
Low consumption lamps	-	By means of contactor	400 W
LED	-	-	600 W
Memory spaces	-	104	22
Application area	Iberian Peninsula and Canary Island	Europe	Spain and Portugal / Algeria, Belgium, France, Luxemburg, Morocco and Tunisia / Denmark, Finland, Norway and Sweden / Italy / Germany / Ireland / England / Turkey / Czechoslovakia and Slovakia / Australia / New Zealand / East European countries / Middle East.(Booking query for other countries)
Automatic s/w change	Yes	Yes	Yes
Installation	Surface (Fastening triangle)	DIN rail	DIN rail
Protection type	IP 52	IP 20	IP 20

Connection diagram

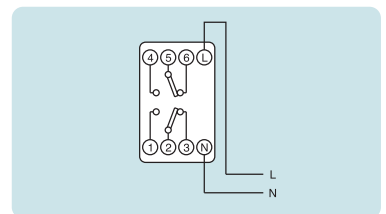
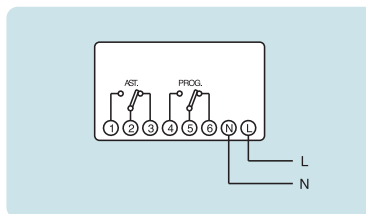
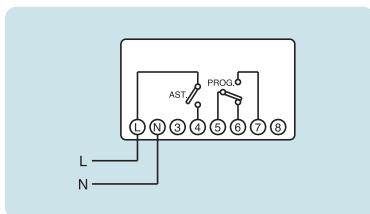

Dimensions

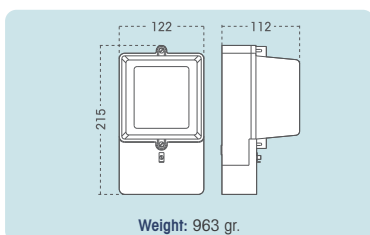

Weight: 963 gr.

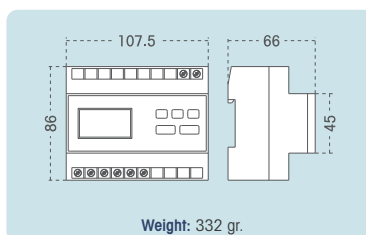

Weight: 332 gr.

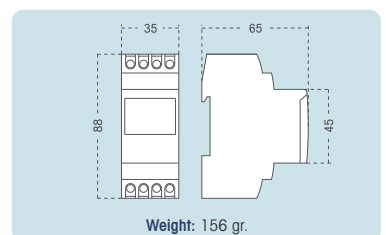

Weight: 156 gr.

ASTRO UNO



ASTRO LOG



ASTRO SAT



Description

Time switches for exterior lighting installations. They automate the on and off time control for the lighting circuits in line with daylight hours in the area where it is installed. Economic saving on installation, maintenance and consumption. Astro Sat has a large display with luminous backlight; furthermore, it can be programmed by way of a remote control.

Features

Rated voltage	120 or 230 Va.c. / 50-60 Hz	230 Va.c. / 50-60 Hz	230 Va.c.
Switching capacity	16 (10) / 250 Va.c.	2x16 (10) A / 250 Va.c.	2x16(10)A / 250 Va.c.
Contact type	Changeover without voltage	Changeover without voltage	Changeover without voltage
Accuracy	± 1 s/day at 23°C	± 1 s/day at 23°C	± 1 s/day at 23°C
Battery back up	≥ 4 years without power supply (lithium battery)	≥ 4 years without power supply (lithium battery)	5 years (Interchangeable battery)
Maximum recommended loads			
Incandescent	3000 W	3000 W	3000 W
Fluorescents	1200 W	1200 W	1200 W
Low voltage halogen	2000 VA	2000 VA	2000 VA
Halogen (230 Va.c.)	3000 W	3000 W	3000 W
Low consumption lamps	400 W	400 W	400 W
LED	600 W	-	600 W
Memory spaces	22	22	70
Application area	Spain and Portugal / Algeria, Belgium, France, Luxembourg, Morocco and Tunisia / Denmark, Finland, Norway and Sweden / Italy / Germany / Ireland / Britain / Turkey / Czech Republic and Slovakia / Australia / New Zealand / Countries in Eastern Europe / Middle East (Booking query for other countries)	Worldwide	Application by country
Automatic s/w change	Yes	Yes	Yes
Installation	Rail DIN	Rail DIN	Rail DIN
Protection type	IP 20	IP 20	IP 20

Connection diagram

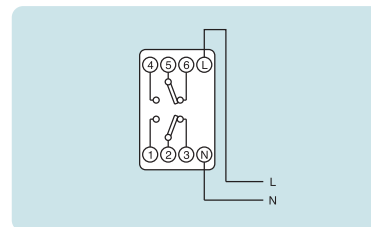
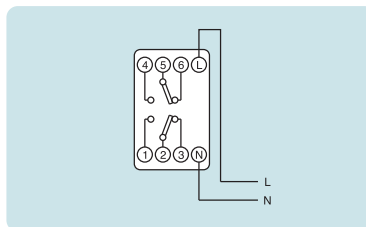
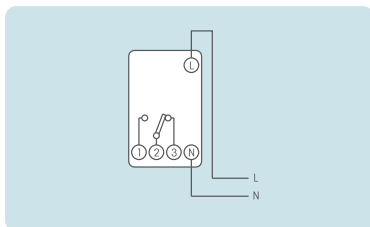

Dimensions

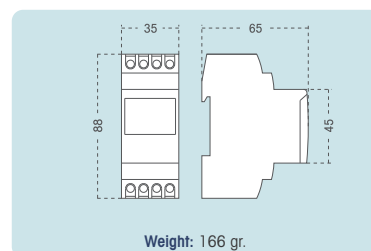
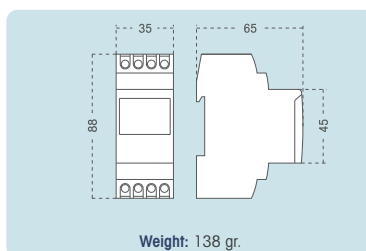
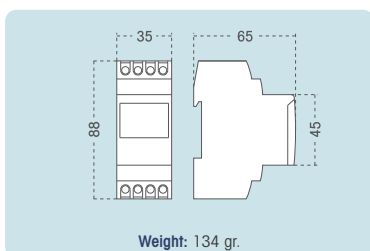



LIGHT FLOW STABILIZERS-DIMMERS

ESDONI

Description

ESDONI equipment is a line-head flux stabiliser-reducer that resolves problems caused by grid instability by stabilising line supply voltage during peak periods. They reduce the voltage during off-peak periods and thus achieve additional savings.

Lighting systems that incorporate discharge lamps associated with ballast of the high-pressure sodium vapour (HPSV) type or mercury vapour (MV) are highly susceptible to supply voltage variations.

Voltages exceeding 105% of the rated value for which they were designed will significantly reduce lamp and equipment life span by increasing electric power consumption.

The graph in Figure 1 shows the great influence of power supply voltage on consumption and on the lifespan of a 400W HPSV lamp. As can be seen, a 7% increase produces a lifespan reduction of 50% and a 16% excess consumption.

In addition, the need to rationalise energy consumption leads to the reduction of public street lighting levels during hours when there are fewer users.

The Energy Efficiency regulation regarding exterior lighting installations indicates to us that "Installations of over 5 kw must be endowed with a light level adjustment system, allowing a reduction in the light flow up to 50%"

High-performance voltage stabiliser-dimmer system

Stabilisers-dimmers are items of equipment designed to generate an energy saving. Hence, the first condition to be met by a system with these characteristics is that it should be extremely efficient. To this end, own consumption must be minimal, raising the performance levels to the maximum. The high-performance flow stabilisers-dimmers over 99% at full load (tests at an official laboratory accredited by ENAC test no. IE-ITE2010100003). These values can be attained thanks to the use of power relays in the switching.

Features

- a) Limiting the current peak when the lamps are switched on.
- b) Stabilising the lighting line rated voltage.
- c) Reduce the lighting line voltage during the hours of fewest users.

Operation graphic

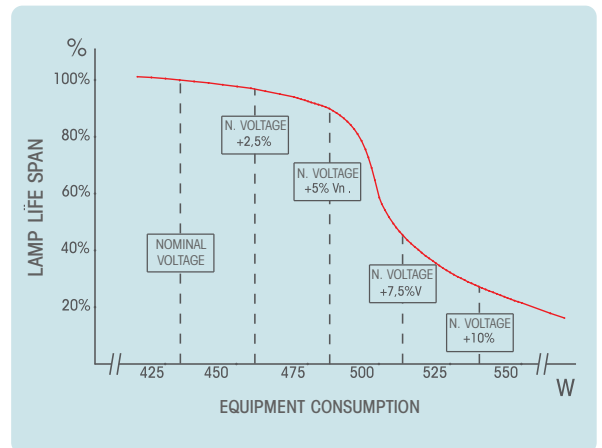
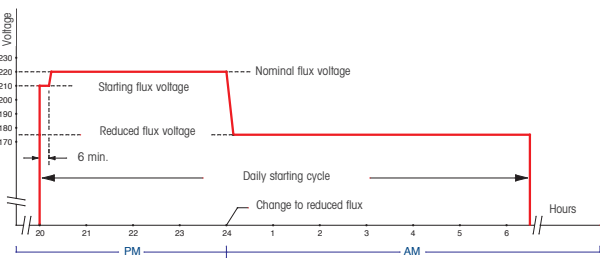
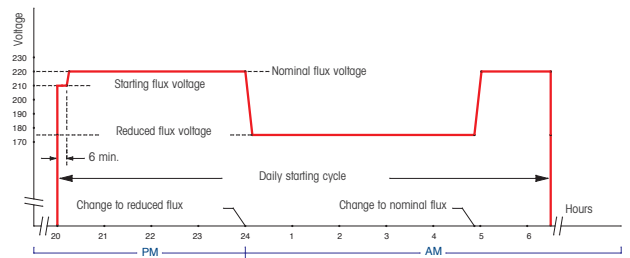

Fig.1: Lamp life span and consumption in function of mains voltage. (Auxiliary equipment - series ballast - 400 W high-pressure sodium vapour)



Equipment start-up regime curve, rating, and reduced until sunrise of the ESDONI equipment..



Start-up regime curve, rating, reduced and return to the rating regime of the ESDONI equipment.

LIGHT FLOW STABILIZERS-DIMMERS

ESDONI-EN



Features	EN10	EN20	EN30	EN40	EN50	EN60
Power (kVA)	10	20	30	40	50	60
Power supply (V) Ve	3 x 400 + N	3 x 400 + N	3 x 400 + N	3 x 400 + N	3 x 400 + N	3 x 400 + N
Admissible variation (V)	± 7%	± 7%	± 7%	± 7%	± 7%	± 7%
Rated mode (V)	220/215/210	220/215/210	220/215/210	220/215/210	220/215/210	220/215/210
Regulation	±1%	±1%	±1%	±1%	±1%	±1%
Start-up mode (V)	210	210	210	210	210	210
R. HPSV mode (V)	175/185	175/185	175/185	175/185	175/185	175/185
Maximum reduction	Ve - 25%	Ve - 25%	Ve - 25%	Ve - 25%	Ve - 25%	Ve - 25%
R. VM mode (V)	195/205	195/205	195/205	195/205	195/205	195/205
Equipment Imax (A)	3 x 15 = 45	3 x 30 = 90	3 x 45 = 135	3 x 60 = 180	3 x 75 = 225	3 x 90 = 270
Phase Imax (A)	15	30	45	60	75	90
Weight (Kg with polyester box)	110	125	160	190	210	220
Weight (Kg with metallic box)	120	135	170	200	220	230
Weight (Kg chassis)	80	95	130	160	180	190

Dimensions

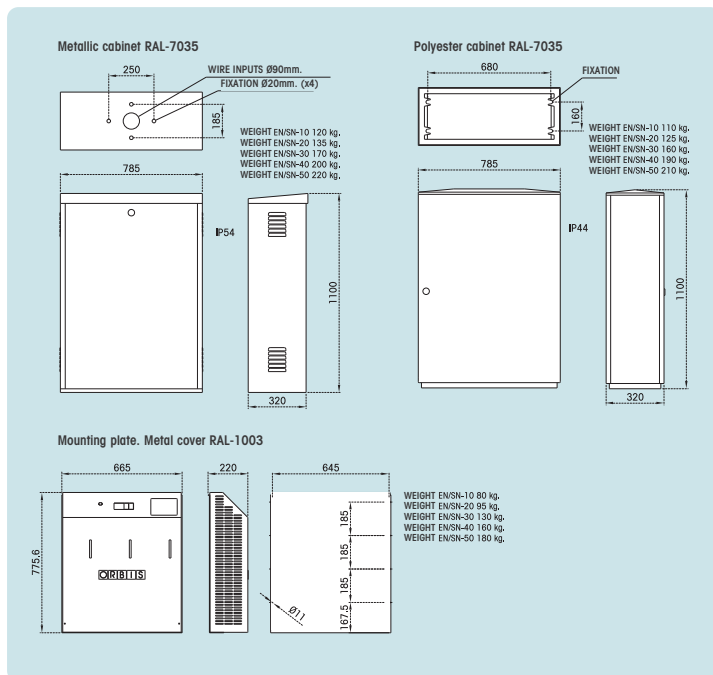

Connection diagram

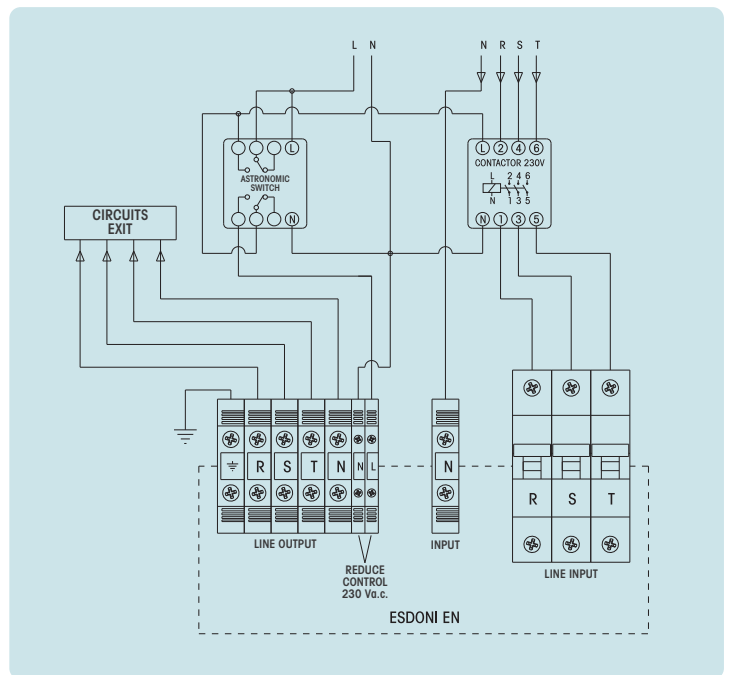

ESDONI-SN

Description

In some towns/cities the three-phase supply is 3 x 230 v/400 v as a norm. In these supplies the loads are disconnected between phases as the voltage between phases is 230 v. For these installations it is necessary to have flow stabilisers-dimmer equipment prepared for providing power without neutral. As in the other versions, the Esdonis-SN can be supplied without a cabinet, with a metallic cabinet or with a polyester cabinet.

Features

Features	SN6	SN12	SN18	SN24	SN30	SN36
Power (kVA)	6	12	18	24	30	36
Power supply (V) V_e	3 x 230	3 x 230	3 x 230	3 x 230	3 x 230	3 x 230
Admissible variation (V)	$\pm 7\%$	$\pm 7\%$	$\pm 7\%$	$\pm 7\%$	$\pm 7\%$	$\pm 7\%$
Rated mode (V)	220/215/210	220/215/210	220/215/210	220/215/210	220/215/210	220/215/210
Regulation	$\pm 1\%$	$\pm 1\%$	$\pm 1\%$	$\pm 1\%$	$\pm 1\%$	$\pm 1\%$
Start-up mode (V)	210	210	210	210	210	210
R. VSAP mode (V)	175/185	175/185	175/185	175/185	175/185	175/185
Maximum reduction	$V_e - 25\%$	$V_e - 25\%$	$V_e - 25\%$	$V_e - 25\%$	$V_e - 25\%$	$V_e - 25\%$
R. VM mode (V)	195/205	195/205	195/205	195/205	195/205	195/205
Equipment I_{max} (A)	3 x 15/ $\sqrt{3}$	3 x 30/ $\sqrt{3}$	3 x 45/ $\sqrt{3}$	3 x 60/ $\sqrt{3}$	3 x 75/ $\sqrt{3}$	3 x 90/ $\sqrt{3}$
p/phase I Max (A)	15/ $\sqrt{3}$	30/ $\sqrt{3}$	45/ $\sqrt{3}$	60/ $\sqrt{3}$	75/ $\sqrt{3}$	90/ $\sqrt{3}$
Weight (Kg with polyester box)	110	125	160	190	210	220
Weight (Kg with metallic box)	120	135	170	200	220	230
Weight (Kg chassis)	80	95	130	160	180	190



Dimensions

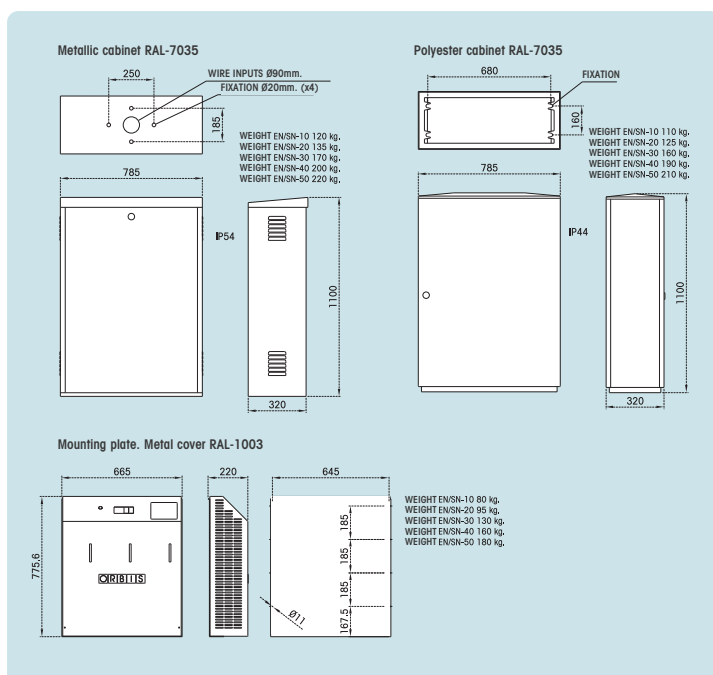

Connection diagram

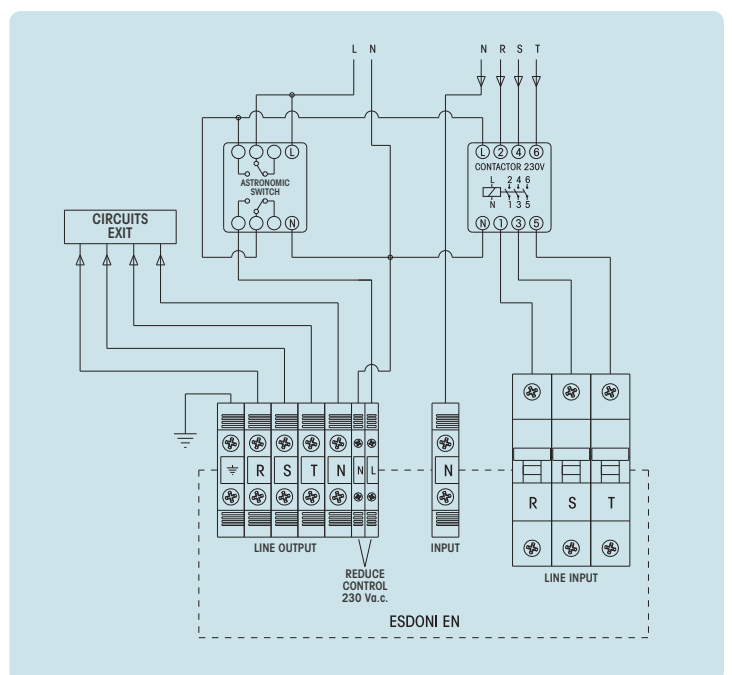

SINGLE PHASE LIGHT FLOW STABILIZERS-DIMMERS

ESDONI-M

Description

The ESDONI-M models are presented as the solution for savings by flux stabilisation and reduction in single-phase public lighting installations. They perform the same functions as the ESDONI-EN equipment for powers of up to 16.6 kVA. Its application is ideal for installations such as sports centre tracks, office building exterior lighting, small gardens and urbanisations etc.



Features

	M3	M6	M10	M16
Power (kVA)	3,3	6,6	10	16,6
Power supply (V)	230	230	230	230
Admissible variation (V)	± 7%	± 7%	± 7%	± 7%
Rated mode (V)	220/215/210	220/215/210	220/215/210	220/215/210
Regulation	±1%	±1%	±1%	±1%
Start-up mode (V)	210	210	210	210
R. HPSV mode (V)	175/185	175/185	175/185	175/185
Maximum reduction	Ve - 25	Ve - 25	Ve - 25	Ve - 25
R. VM mode (V)	195/205	195/205	195/205	195/205
Equipment I _{max} (A)	15	30	45	75
Weight (Kg with polyester box)	46	51	63	79
Weight (Kg with metallic box)	60	65	75	95

Dimensions

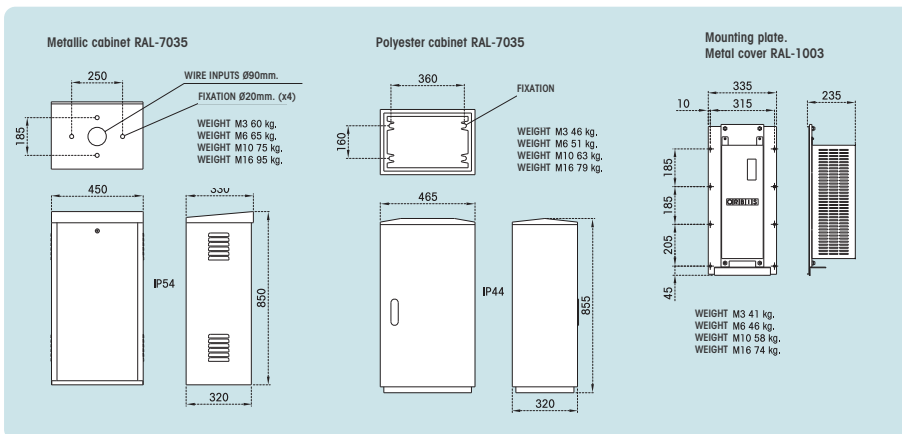

Connection diagram

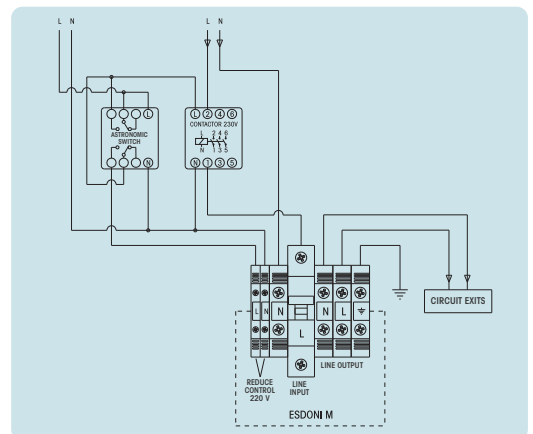

LIGHT FLOW STABILIZERS-DIMMERS ACCESORIES

Control Auxiliary ARL

Public lighting installations comprise equipment with HPSV or MV lamps. Equipment with series ballast and HPSV lamps can be regulated and their power reduced to 40% of the rated value. Equipment with MV lamps and series ballast can be reduced to 25% of their rated power value. Reductions of below 195 V produce switch off.

The regulation auxiliaries allow voltage to be reduced to 175 V without any undesired switch-off or instability and can produce savings of up to 35% with VM lamps for voltage values of 175V. The incorporation of regulation auxiliaries can produce similar savings figures with HPSV and MV lamps in installations sharing both types or only with MV lamps.

ARL-1: Lamps of 80 and 125 W.

ARL-2: Lamps of 250 and 450 W.

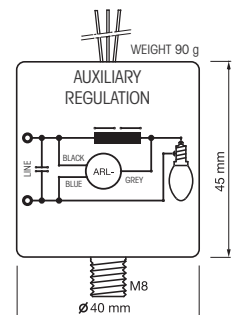

XEO LUM MODULAR



Description

The modular Xeo Lum enables us both to modify the internal parameters of the Esdoni high-performance flow stabiliser-dimmer (voltage level stabilised, maximum dimming and dimming staggered by time periods...) and to interact with the command centre (resettable tripping breaker, magneto-thermal, astronomic programming alarms etc.)

All these options provide us with the appropriate lighting for the requirements of the street both generally and from time to time, without the need to send a maintenance technician to the installation. To adapt this type of installations, consult the Orbis' after-sales service.

The Modular Xeo Lum affords the possibility of incorporating a remote control management system when required for installations which may or may not have a Stabiliser-Dimmer, whether it is an Esdoni or equipment from some other manufacturer.

The Modular Xeo Lum can be adapted to any existing control centre owing to its size of 9 modules and installation on a Din rail.

Thanks to this modular assembly type we can integrate a remote management system at conventional control centres or at those which incorporate a savings system.

The modular system incorporates the main functions required in remote management such as consumption, voltages, powers, coseins per phase, input and output status etc. Internally it incorporates two complete network analysers to measure both the power input and output at lights. All this information can be viewed on the display.

One of the main characteristics in the connection is the number of auxiliary outputs and inputs.

- 10 auxiliary inputs
- 4 auxiliary outputs
- 2 RS 485 Ports (Modbus expansions, peripherals and another for Esdoni card control)
- 1 RS 232 port

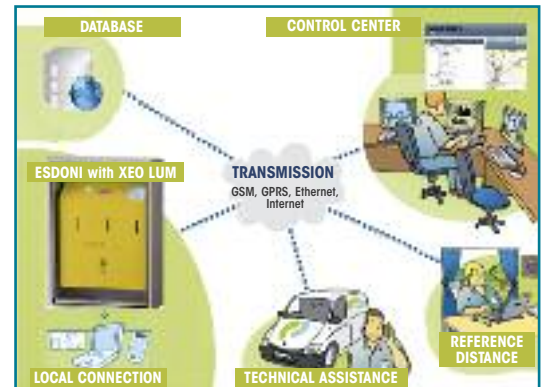

Terminals

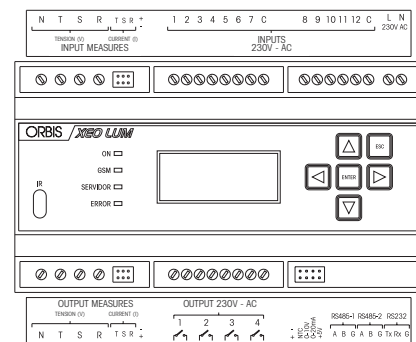

The common input terminals are independent

Examples of Installation

Control centre without savings system:

In this event we can have the remote management and integration of the alarms, astronomic programming, consumption, voltages, auxiliary outputs...

Two-level control centre with command line:

With the Modular Xeo Lum we can carry out the programming, both astronomic and with the reduced timetable, whenever it is two level with a command line (a very useful functionality for comparing consumption before and after starting the reduction).

Control centres which have a Stabiliser-Dimmer:

In the event of installing a Modular Xeo Lum at control centres which are endowed with Esdoni high performance flow Stabiliser-Dimmer systems, we are able to endow the installation with high energy efficiency, expanding the possibilities both in the management of installations as well as in the control and maintenance thereof.

ORBICOM / NODITEL



Description

The remote management system for electrical boards is a product designed to perform the functions of measurement analyser and fault detection, together with their remote management via GSM communications, thus supplementing the ESDONI flux stabilisers-reducers equipment offer. Its main goal is to have the main lighting board parameters available from a central post and mobile units, together with certain situations that could require immediate technical assistance or awareness, such as protection trips, board opening, wiring theft and lamp replacement.

The remote management system consists of two main equipment units:

A master designated ORBICOM is responsible for carrying out electrical measurements, providing direct information on its display and establishing communications; and also several slave nodes designated NODITEL that are connected to the various board lines and which monitor operations and their protections and continually transmit operating and anomaly information to the master.

Example of controlling by means of ORBICOM

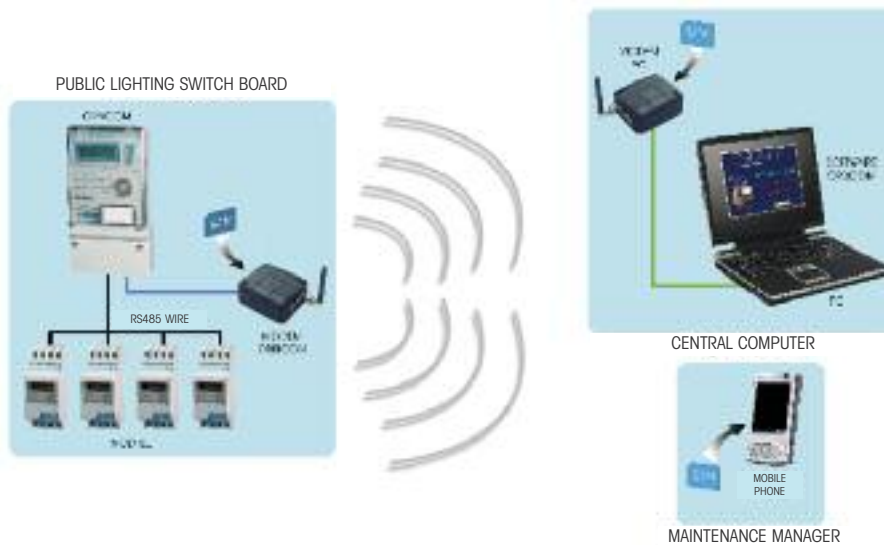

NOTE: The operation of the equipment is subject to the characteristics of the GSM communication of the country. Other configurations are possible. Consult.

Software



In order to obtain enhanced control of the installations that are fitted with ORBICOM equipment, a GSM modem may be connected to this, which will send information to a central computer as well as to the various maintenance teams' mobile telephones via SMS.

Commands can be sent to the installations at the same time as alarms and information are being issued from them. In order to better define the parameters required by each maintainer, such as alarms, load curves and SMS etc.

A control software is available that allows: the creation of an independent file per board / display reading in local or remote / command transmission / the configuration of each ORBICOM / data and fault recording / graphical parameter display / astromonic or fixed lighting programming.



REMOTE MANAGEMENT SYSTEMS FOR ELECTRICAL BOARDS

ORBICOM

The master module, designated ORBICOM, is an autonomous element that is installed on the lighting board and which performs the following functions:

- It measures the line voltage in true r.m.s. value between each phase and neutral, reaches 255 V.
- It measures the active power in each of the three phases.
- Maximum current: 80 A per phase.
- It will calculate the cos ϕ for each of the three phases.
- It will calculate the active power in each of the three phases, between each phase and neutral.
- It will calculate the total active power.
- It incorporates configurable astronomical switch on and switch off operations.
- It will measure the voltage in true r.m.s. value between each phase and neutral at the lighting line outputs, when installed with ESDONI equipment, reaches 255 V.
- It calculates the savings for each phase in %, when installed with ESDONI equipment.
- It calculates the total savings in % when installed with ESDONI equipment.
- Intruder, wiring theft and blown lamp alarms.
- Connection for up to 15 NODITEL units per RS-485 port.
- Direct event reading on the equipment display.
- Remote data transmission to a central unit over RS-232 modem, via GSM modem, telephone wires etc.
- Remote programming of switch on and switch off in astronomical or fixed mode.

Features

Rated line voltage	3 x 230/400 Va.c.
Measured voltage	3 x 230 Va.c. + N
Maximum current per phase	80 A
Frequency	50 Hz
Own consumption	Approx. 20 VA
Battery back up	6 years using a lithium battery
Operational precision	< $\pm 0,5$ s/24 h at 23 °C
Operating temperature	-10 °C to + 45 °C
Precision accuracy class	Class 1 active power - Class 2 reactive power
Protection class	II adequate mounting
Protection type	IP 51
Mechanical strength	IK 06
Installation	Fastening triangle in surface according to DIN 43857

Dimensions

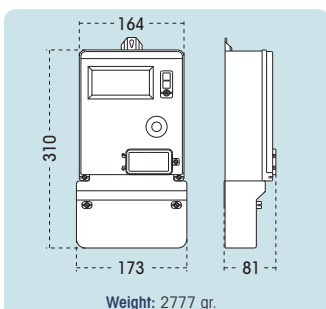

Connection diagram

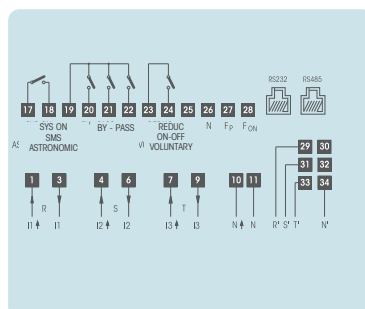

NODITEL

Reduc on/off voluntario: ON/OFF Voluntary reduction. The nodes designated NODITEL are elements that are supplementary to the ORBICOM that enable system functions to be expanded, acquiring data and transmitting them to the master. Their most important specifications and functions are:

- Nodes that communicate with the ORBICOM via RS-485.
- Detection of fuse, breaker earth-leakage breaker failures etc. (by detecting voltages of less than 160V R.M.S.).
- Each NODITEL includes DIP switches for address programming.
- The RS-485 can connect to a maximum of 15 NODITEL slaves.
- Direct power supply connection to the 230 V grid.
- When power is applied to the module, the green LED is switched on indicating power is present. If there are no problems, the Green LED will flash at a rate of 0.5 seconds ON/1 second-OFF.
- If the unit detects a problem, for example, a missing or low (less than 160 V) phase, the red LED ROJO will flash at a higher rate (0.1 seconds Ton and 0.1 seconds Toff).
- Each module can detect the voltage in up to three phases in the same line, which is R, S and T with its neutral, or between phase and neutral in single-phase lines.

Features

Rated line voltage	230 Va.c.
Measured voltage	3 x 230 Va.c. + N
Alarm voltage per phase	160 Va.c.
Frequency	50 Hz
Own consumption	Approx. 5 VA
Operating temperature	-10 °C to + 45 °C
Precision class	Class 1
Protection class	II adequate mounting
Protection type	IP 20
Mechanical strength	IK 02
Installation	On the top of the symmetrical profile measuring 35mm using EN60715. DIN Rail.

Dimensions

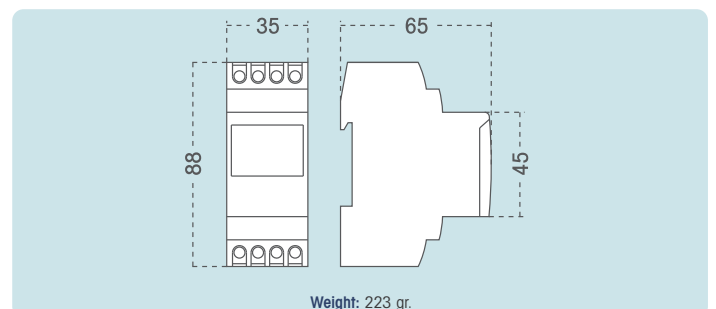

KIT SOLARGEST REMOTE MANAGEMENT OF PHOTOVOLTAIC PLANTS BY SMS



➤ Description

The Kit Solargest is a new, innovative remote management product designed to control and administer single-phase or three-phase photovoltaic installations (direct/indirect) by way of the broadest, most economical transmission technology (SMS).

➤ Features

Notifies when there is no energy production even when there is sun:

Thanks to the solar radiation sensor and the energy meter the system is capable of analysing whether something isn't working properly. If it is sunny and the energy level produced by the solar panels is low, the system will send an SMS notification message.

Calculates the income per generation:

When it asked for information the kit sends an SMS with the production value in Euros or in some other currency. Thanks to the energy meter connection, by knowing the price of the KWH, the Solargest kit can be programmed to calculate the generation and send the information periodically (e.g. every week or month).

It is simple and functional:

It is assembled on the DIN rail and is very easy to install. Furthermore, it is compatible with all European mobile phone operators and is easy to programme via SMS.

It also works as an antitheft alarm:

Thanks to a digital input (where it is possible to connect a microswitch, presence detectors, optical barrier etc..) It monitors whether anyone is trying to steal the solar panels or entering a forbidden area. The Solargest kit sends an alarm SMS to a phone and activates a relay where it is possible to connect a sound alarm and/or a flashing light.

Measures the instantaneous power produced:

By calling the Solargest kit, in a few seconds an SMS will be received indicating the instantaneous power produced.

Warns whether there is a blackout:

Thanks to an integrated battery, the Solargest Kit informs if there is no power supply, meaning that it is possible to access the network immediately. If, in the meantime, the normal power supply conditions return, it can avoid system supervision thanks to another message which will inform about the new situation.

PÁG. 54 | DIGITAL VOLTMETERS / AMPMETERS AND FREQUENCYMETERS



METRA Q-H / METRA M-H



METRA Q-A / METRA M-A



METRA Q-V / METRA M-V



METRA Q-V+A / METRA Q-V/A
METRA M-V+A / METRA M-V/A



METRA Q-V/A-R / METRA M-V/A-R

PÁG. 55 | MODULAR NET ANALIZER



ANRET M-22



ANRET M-22-BUS



ANRET M-63



ANRET M-90A-BUS



ANRET Q / ANRET M



ANRET Q-BUS / ANRET M-BUS



ANRET Q-R / ANRET M-R



ANRET Q-MULTI / ANRET M-MULTI

DIGITAL VOLTMETERS / AMPMETERS AND FREQUENCYMETERS

METRA Q-H METRA M-H



METRA Q-A METRA M-A



METRA Q-V METRA M-V



METRA Q-V+A / METRA Q-V/A METRA M-V+A / METRA M-V/A



METRA Q-V/A-R METRA M-V/A-R



Description

FREQUENCYMETER

AMPMETER

VOLTMETER

VOLTMETER/ AMPMETER

VOLT./ AMPM. WITH RELAY

Measuring elements for electrical parameters, such as voltage, current and frequency. Installation either DIN rail or panel. For alternative or direct current, up to 4,000 amps via a current transformer

Features

Rated voltage	115/230 Va.c / 50-60 Hz	115/230 Va.c / 50-60 Hz	115/230 Va.c / 50-60 Hz	115/230 Va.c / 50-60 Hz	115/230 Va.c / 50-60 Hz
Transformers range selectable		Metra Q-Ax / Metra M-Ax: 5-10-25-50-60-100-125-150-200-250-300-400-500-600-700-800-1000-1500-2000-2500-4000/5 A		5-10-25-50-60-100-125-150-200-250-300-400-500-600-800-1000-1500-2000-2500-4000/5 A	5-10-25-50-60-100-125-150-200-250-300-400-500-600-800-1000-1500-2000-2500-4000/5 A
Operating temperature	-10 °C to +50 °C	-10 °C to +50 °C	-10 °C to +50 °C	-10 °C to +50 °C	-10 °C to +50 °C
Protection Type / Class	IP 40 / 2	IP 40 / 2	IP 40 / 2	IP 40 / 2	IP 40 / 2

Models

H (Frequencymeter)

A (Ampmeter)

V (Voltmeter)

V+A (Voltmeter and Ampmeter)
V/A (Voltmeter or Ampmeter)

V/A-R (Voltmeter or Ampmeter with programmable out put relay)

Q
Panel model
(72x72 mm.)*

METRA Q-H:
Accuracy 0,1 Hz.

METRA Q-A 10A AC:
Up to 10 A c.a.
Accuracy 10 mA.

METRA Q-A 10A DC:
Up to 10 A c.c.
Accuracy 10 mA.

METRA Q-A xA:
Up to 4000/5 A c.a.

METRA Q-V 1V DC:
Up to 1 Vc.c.
Accuracy 1 mV.

METRA Q-V 10V DC:
Up to 10 Vc.c.
Accuracy 10 mV.

METRA Q-V 100V DC:
Up to 100 Vc.c.
Accuracy 0,1 V.

METRA Q-V 600V DC:
Up to 600 Vc.c.
Accuracy 1 V.

METRA Q-V+A:
Voltmeter up to 600 Va.c and amp meter by transformers

METRA Q-V/A:
Voltmeter up to 600 Va.c. or amp meter by transformers.

METRA Q-V/A-R:
600 Va.c. / Amp meter by transformers with programmable out put relay.

M
Rail DIN model

METRA M-H:
Accuracy 0,1 Hz.

METRA M-A 10A AC:
Up to 10 A c.a.
Accuracy 10 mA.

METRA M-A 10A DC:
Up to 10 A c.c.
Accuracy 10 mA. 72x72 mm.

METRA M-A xA:
Up to 4000/5 A c.a.

METRA M-V 1V DC:
Up to 1 Vc.c.
Accuracy 1 mV.

METRA M-V 10V DC:
Up to 10 Vc.c.
Accuracy 10 mV.

METRA M-V 100V DC:
Up to 100 Vc.c.
Accuracy 0,1 V.

METRA M-V 600V DC:
Up to 600 Vc.c.
Accuracy 1 V.

METRA M-V+A:
Voltmeter up to 600 Va.c and amp meter by transformers. Modular.

METRA M-V/A:
Voltmeter up to 600 Va.c or amp meter by transformers. Modular.

METRA M-V/A-R:
600 Va.c / Amp meter by transformers with programmable out put relay.

Dimensions

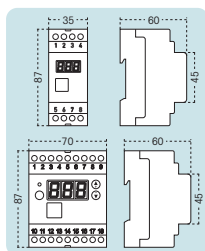
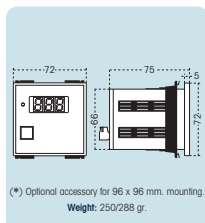

Connection diagram

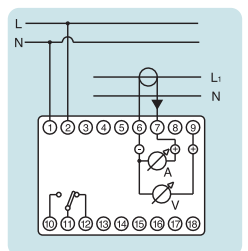
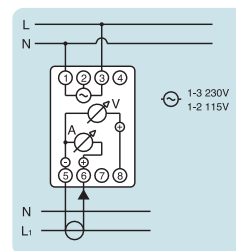
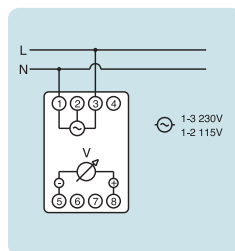
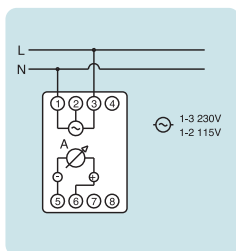
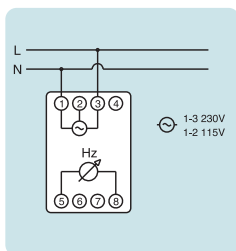
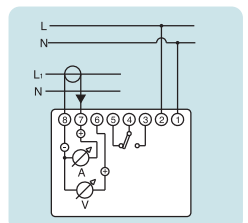
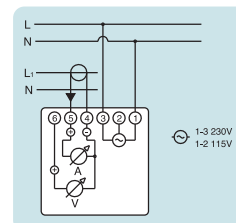
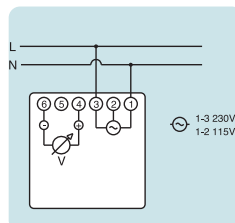
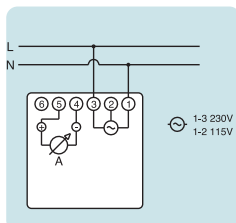
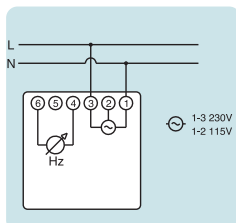

MODULAR NET ANALIZER

ANRET M-22



SINGLE PHASE 22A

ANRET M-22-BUS



SINGLE PHASE 22A WITH COMMUNICATION BUS

ANRET M-63



SINGLE PHASE 63A WITH PULSE OUTPUT

ANRET M-90A-BUS



THREE PHASE 90A WITH COMMUNICATION BUS

Description

Multi-function measuring elements for electrical parameters in single or three-phase systems. From 22 amps direct measurement up to 9,999 amps via a current transformer. Communication and DIN rail installation options

Features

Rated voltage	230 Va.c. / 50-60 Hz	230 Va.c. / 50-60 Hz	230 Va.c. / 50-60 Hz	400 Va.c. / 50-60 Hz
Intensity Input	I _b = 5A; I _{max} = 22,5A direct connection	I _b = 5A; I _{max} = 22,5A direct connection or I _n = 5A; I _{max} = 6A by transformers x/5A.	I _b = 10A; I _{max} = 63A by cable pass	I _b = 10A; I _{max} = 90A by cable pass
Transformers range selectable	-	1 ... 9.999/5A	-	-
V max	300 V	300 V	230 V	Three Phases net analyzer 440 V
Parameters	- Voltage V (TRMS) - Current A (TRMS) - Power W - Power factor (cos φ) - Energy Wh - Frequency Hz	- Voltage V (TRMS) - Current A (TRMS) - Power W - Power factor (cos φ) - Energy Wh - Frequency Hz	- Voltage V (TRMS) - Current A (TRMS) - Power W - Power factor (cos φ) - Energy Wh - Frequency Hz	- Voltage V (TRMS) - Phase sequence - Current A (TRMS) - Active Power W - Reactive Power Var - Apparent Power VA - Active Energy Wh - Reactive Energy VAh - Power factor (cos φ) - Phase angle - Frequency Hz
Display	LCD, 7 + 5 digits retro illuminated screen	LCD, 7 + 5 digits retro illuminated screen	LCD, 7 + 5 digits retro illuminated screen	LCD retro illuminated screen
Operating temperature	-10 °C to + 45 °C	-10 °C to + 45 °C	-10 °C to + 45 °C	0 °C to + 45 °C
Installation/ Module numbers	DIN/3	DIN/3	DIN/3	DIN/7
Protection type/ Protection class	IP 20/2	IP 20/2	IP 20/2	IP 20/2
Optional	-	Software in order to read through RS485	-	Software in order to read through RS485

Connection diagram

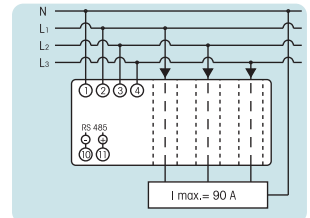
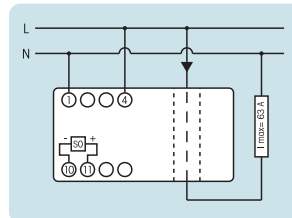
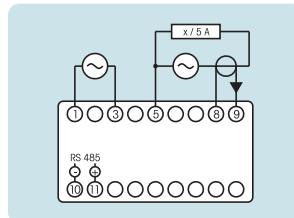
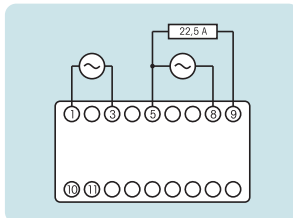

Dimensions

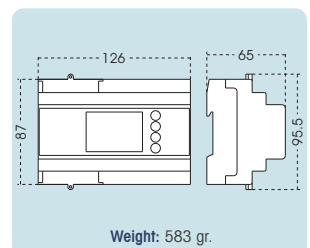
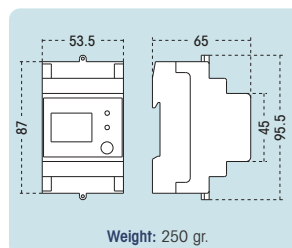
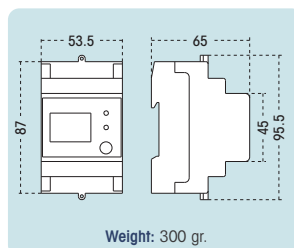
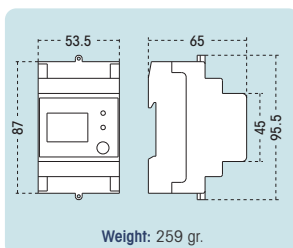

THREE PHASE NET ANALIZER

SINGLE PHASE/THREE PHASE

**ANRET Q
ANRET M**



BY TRANSFORMERS

SINGLE PHASE/THREE PHASE

**ANRET Q-BUS
ANRET M-BUS**



BY TRANSFORMERS WITH
COMMUNICATION BUS

SINGLE PHASE/THREE PHASE

**ANRET Q-R
ANRET M-R**



BY TRANSFORMERS WITH
2 OUTPUT RELAYS

THREE PHASE

**ANRET Q-MULTI
ANRET M-MULTI**



WITH MULTIPLE LED DISPLAY
BY TRANSFORMERS

Description

Multi-function measuring elements for electrical parameters in three-phase systems up to 9,999 amps via a current transformer. Communication, DIN rail and rear-board installation options.

Features

Rated voltage	230 Va.c. / 50-60 Hz	230 Va.c. / 50-60 Hz	230 Va.c. / 50-60 Hz	115/230 Va.c. / 140/300V c.c. / 50-60 Hz
Intensity Input	I _b = 5A; I _{max} = 9999A by indirect connection	I _b = 5A; I _{max} = 9999A by indirect connection	I _n = 5A; I _{max} = 9999A by indirect connection	I _n = 5A; I _{max} = 9999A by indirect connection
V max	550 V	550 V	550 V	500 V
Parameters	- Voltage V (TRMS) – Sequence and phase - Current A (TRMS) – Active Power W – Reactive Power Var – Apparent Power VA – Active energy Wh – Reactive energy VARh – Power factor (cos φ) – Phase angle - Frequency Hz	- Voltage V (TRMS) – Sequence and phase - Current A (TRMS) – Active Power W – Reactive Power Var – Apparent Power VA – Active Energy Wh – Reactive Energy VARh – Power Factor (cos φ) – Phase angle - Frequency Hz	- Voltage V (TRMS) – Sequence and phase - Current A (TRMS) – Active Power W – Reactive Power Var – Apparent Power VA – Active Energy Wh – Reactive Energy VARh – Power Factor (cos φ) – Phase Angle - Frequency Hz	- Voltage V (TRMS) – Sequence and phase - Current A (TRMS) – Active Power W – Reactive Power Var – Apparent Power VA – Active Energy Wh – Reactive Energy VARh – Power Factor (cos φ) – Phase Angle - Frequency Hz
Display	LCD retro illuminated screen	LCD retro illuminated screen	LCD retro illuminated screen	LED
Operating temperature	-10 °C to + 45 °C	-10 °C to + 45 °C	-10 °C to + 45 °C	0 °C to + 45 °C
Installation / Module numbers	DIN / 3	DIN / 3	DIN / 3	DIN / 9
Protection type / class	IP 20 / 2	IP 20 / 2	IP 20 / 2	IP 20 / 2
Optional	-	Software for reading via RS485	-	-

Dimensions

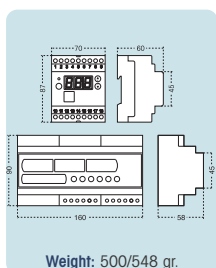
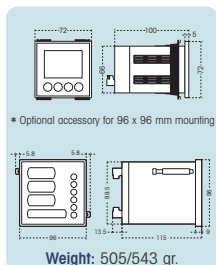

Connection diagram

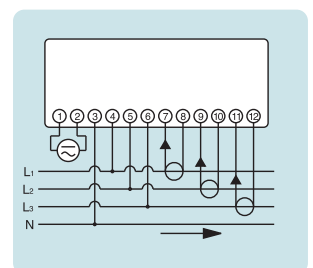
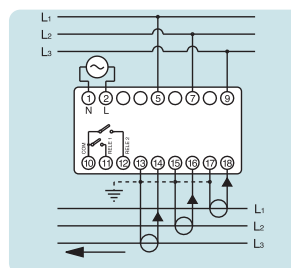
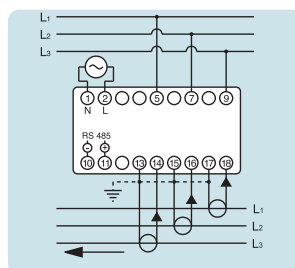
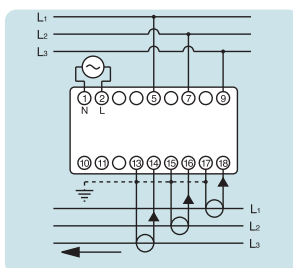
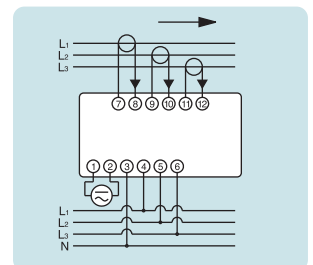
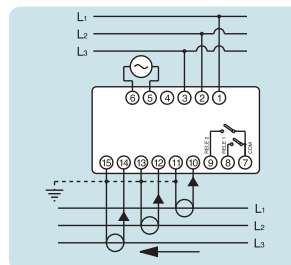
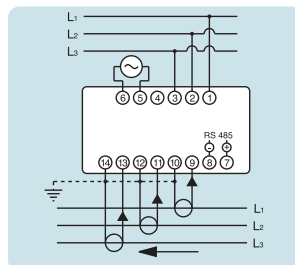
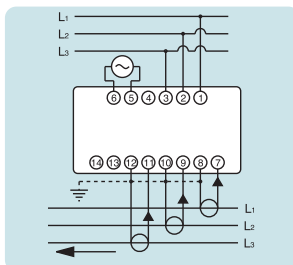



ORBIS TECNOLOGÍA ELÉCTRICA, S.A.
Lérida, 61. E-28020 MADRID
Tel.: +34 91 567 22 77
Fax: +34 91 571 40 06
www.orbis.es • info@orbis.es

A047.00.53247 Depósito Legal: M-35926-2007. Edición: Octubre 2011

Distributor:



ISO 9001

ORBIS TECNOLOGÍA ELÉCTRICA, S.A. reserves the right to modify totally or partially technical features specified on this catalogue.