

High voltage LED Strip RF dimmer

Model No.: S1-HV

1 Channel / Step-less Dimming / Push-Dim / Wireless Remote Control

Features

- High voltage LED Strip RF 2.4G dimmer, can control maximum about 25 meters of high voltage LED strip, different LED strip may have difference.
- Match with RF 2.4G single zone or multiple zone single color remote control.
- One RF controller accept up to 10 remote control.
- Auto-transmitting function: Controller automatically transmit signal to another controller with 30m control distance.
- Synchronize on multiple number of controllers.
- 4096 levels 0-100% dimming smoothly without any flash.
- Light on/off fade time 3s selectable.
- Connect with external AC push switch to achieve on/off and 0-100% dimming function.

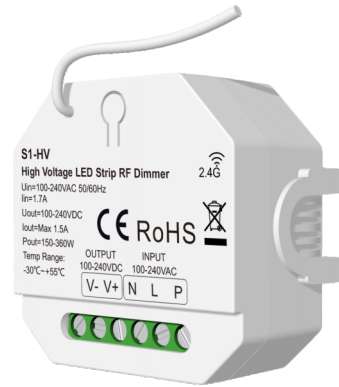

FC CE RoHS EMC LVD RED

Technical Parameters

| Input and Output | | Dimming data | | Safety and EMC | |
|-------------------------|-------------------|--------------------|--------------------------------|----------------------|---|
| Input voltage | 100-240VAC | Input signal | RF 2.4GHz + Push Dim | EMC standard (EMC) | ETSI EN 301 489-1 V2.2.3 ETSI EN 301 489-17 V3.2.4 |
| Input current | 1.7A | Dimming gray scale | 4096 (2 ¹²) levels | Safety standard(LVD) | EN 62368-1:2020+A11:2020 |
| Output voltage | 100-240VDC | Dimming range | 0 - 100% | Radio Equipment(RED) | ETSI EN 300 328 V2.2.2 |
| Output current | Max 1.5A | PWM Frequency | 2KHz | Certification | CE, EMC, LVD, RED |
| Output power | 150-360W | Package | | Warranty | |
| Environment | | Size | L56xW56xH35mm | Warranty | 5 years |
| Operation temperature | Ta: -30°C ~ +55°C | Gross weight | 0.067kg | | |
| Case temperature (Max.) | Tc: +85°C | | | | |

Mechanical Structures and Installations

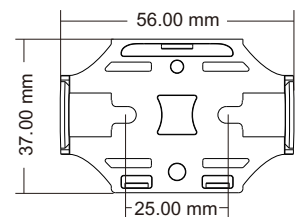
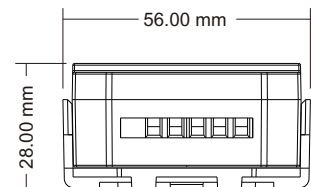
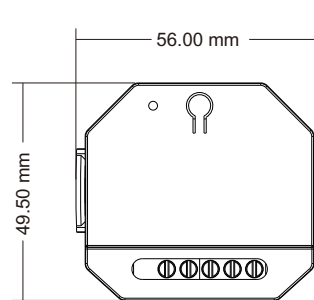
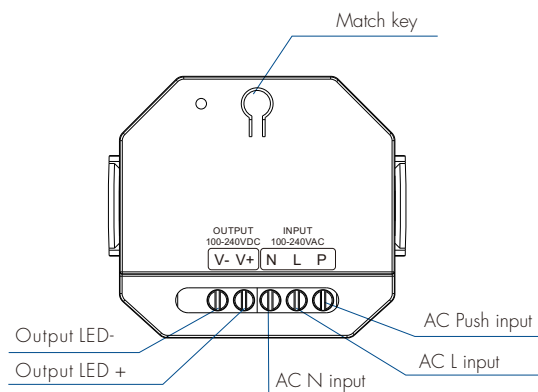

Match remote control

End user can choose the suitable match/delete ways. Two options are offered for selection:

Use the Match key

Match:
Short press match key, immediately press on/off key (single zone remote) or zone key (multiple zone remote) on the remote. The LED indicator fast flash a few times means match is successful.

Delete:
Press and hold match key for 5s, The LED indicator fast flash a few times means all matched remotes were deleted.

Use Power Restart

Match:
Switch off the power, then switch on power, repeat again. Immediately short press on/off key (single zone remote) or zone key (multiple zone remote) 3 times on the remote. The light blinks 3 times means match is successful.

Delete:
Switch off the power, then switch on power, repeat again. Immediately short press on/off key (single zone remote) or zone key (multiple zone remote) 5 times on the remote. The light blinks 5 times means all matched remotes were deleted.

Wiring Diagram

⚠ Caution: This controller apply for high voltage LED strip, please carefully ensure all wire connections and polarities are correct and secure before applying power, otherwise this dimmer or high voltage LED strip will be damaged.

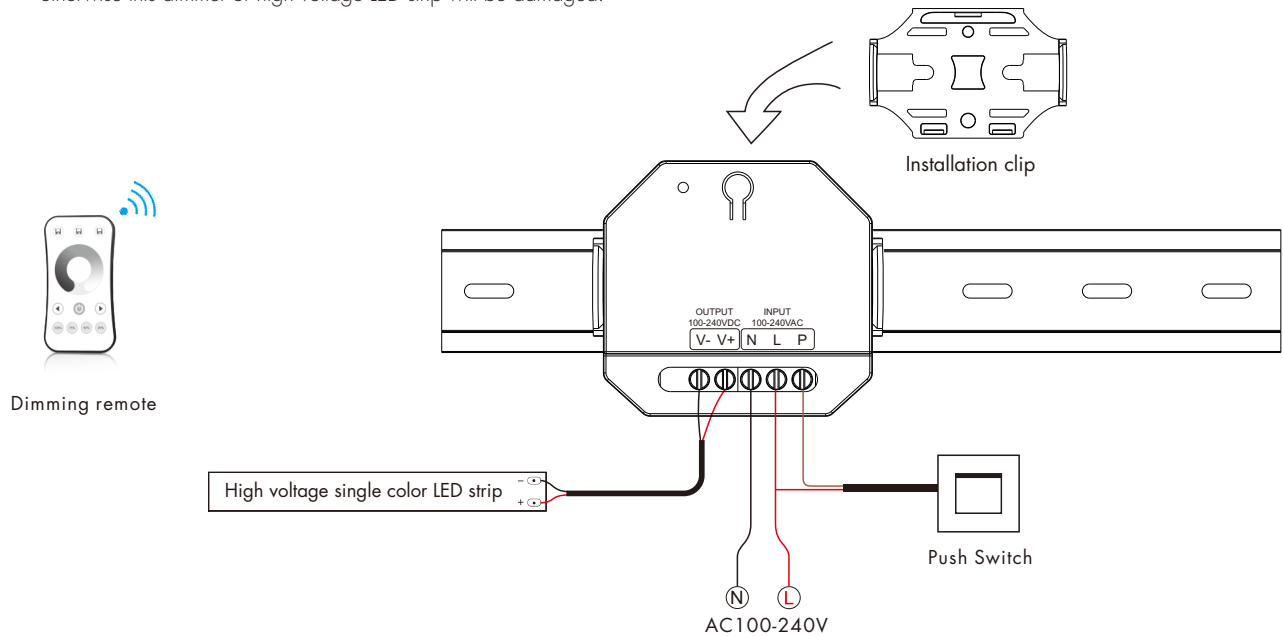

Note:

1. The installation must be installed or removed by a professional electrician.
2. Please keep the device out of the reach of children.
3. Please keep away from water, humid or hot environment.
4. The device should be kept away from strong signal sources (such as microwave ovens) to avoid signal interruption and cause the device not to work properly.
5. Avoid placing the device close to or near high-density materials (such as metal, concrete walls, etc.), which will reduce or block the wireless signal.

Fade in and Fade out Setting

Long press match key 5s, then short press match key 3 times,
The lighting effect will be set to the fade in and fade out in 3s, the indicator light of LED controller blinks 3 times.
Long press match key 10s, restore factory default parameter, the light on/off time restores to 0.5s.

AC Push Dim Function

Short press: Turn on or off light.

Long press (1-6s): Press and hold to step-less dimming, With every other long press, the light level goes to the opposite direction.

Dimming memory: Light returns to the previous dimming level when switched off and on again, even at power failure.

Application notes

1. All the receivers in the same zone.

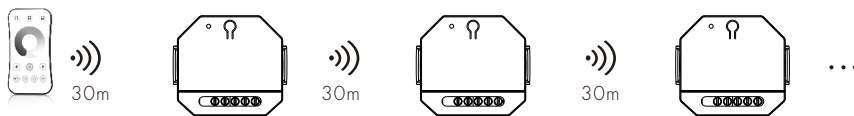

RF remote

Auto-transmitting: One receiver can transmit the signals from the remote to another receiver within 30m, as long as there is a receiver within 30m, the remote control distance can be extended.

Auto-synchronization: Multiple receivers within 30m distance can work synchronously when they are controlled by the same remote.

Receiver placement may offer up to 30m communication distance. Metals and other metal materials will reduce the range.

Strong signal sources such as WiFi routers and microwave ovens will affect the range.

We recommend for indoor applications that receiver placements should be no further apart than 1.5m.

2. Each receiver(one or more) in a different zone, like zone 1, 2, 3 or 4.

